

Part No:	GH-43101
Holding Capacity:	170Kg
Weight:	0.3Kg

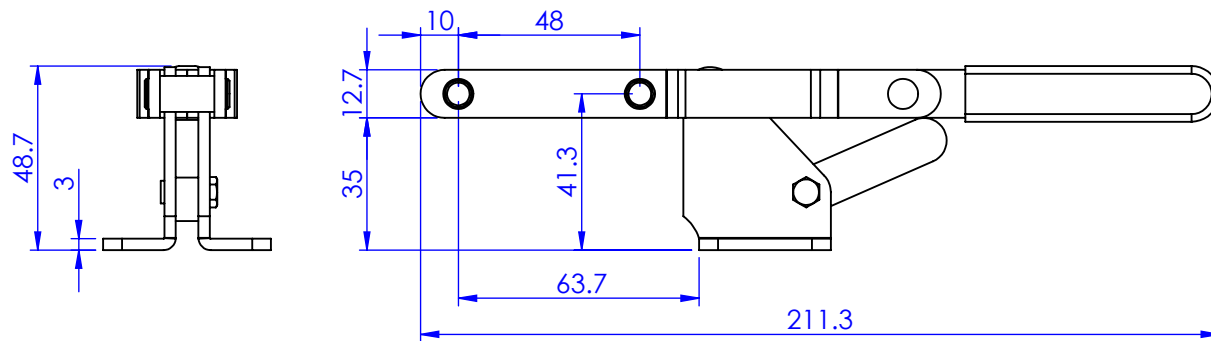
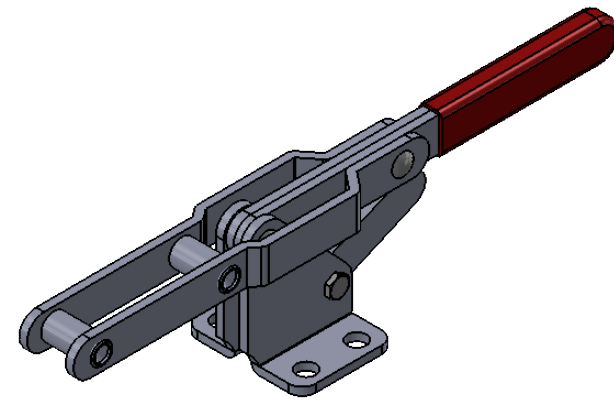
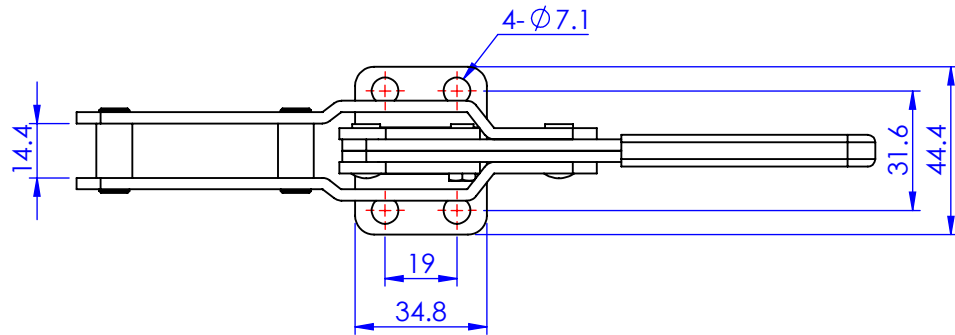

Unit:mm
Scale: 1:2

 **Good Hand Enterprise Co., Ltd**

TITLE:		
DWG NO.	GH-43101	A4