

Part No:	GH-36092M
Holding Capacity:	180Kg
Plunger Stroke:	31.8 mm
Handle Opens:	180°
Weight:	0.38Kg
Spindle Supplied:	SA-085012

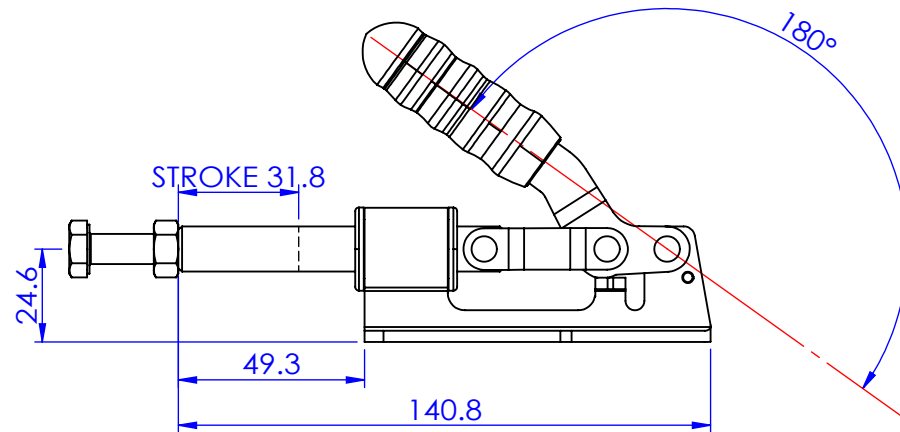

Unit:mm
Scale: 1:2

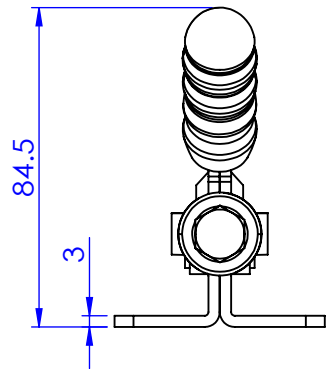
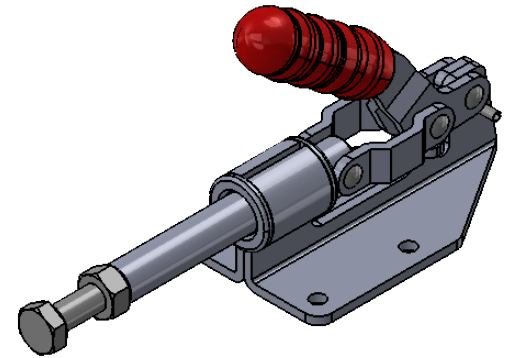
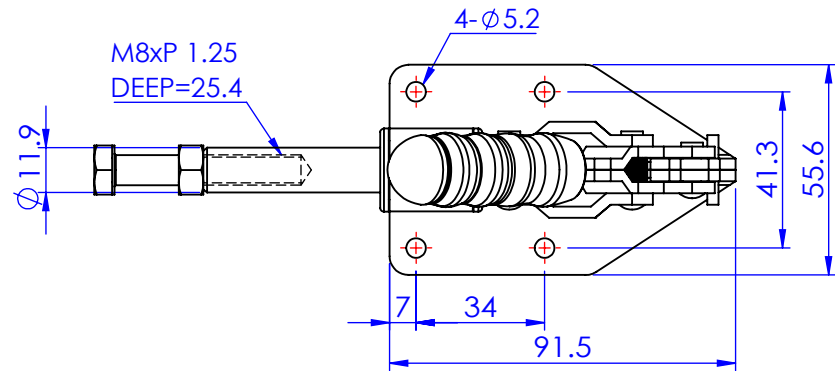

Good Hand Enterprise Co., Ltd

TITLE:

DWG NO.

GH-36092M

A4