

Part No:	GH-35000HL
Holding Capacity:	5000Kg
Plunger Stroke:	100 mm
Handle Opens:	185°
Weight:	7.97Kg
Spindle Supplied:	SA-167520

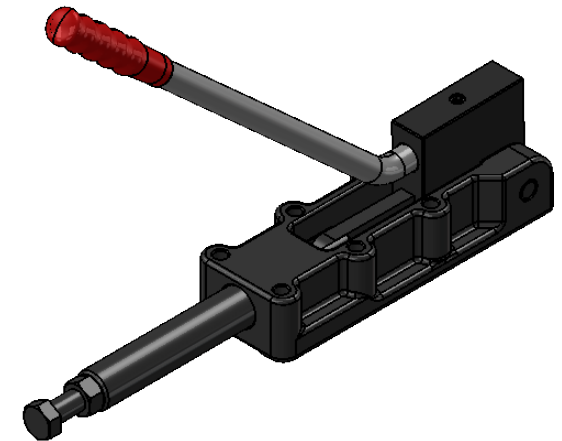
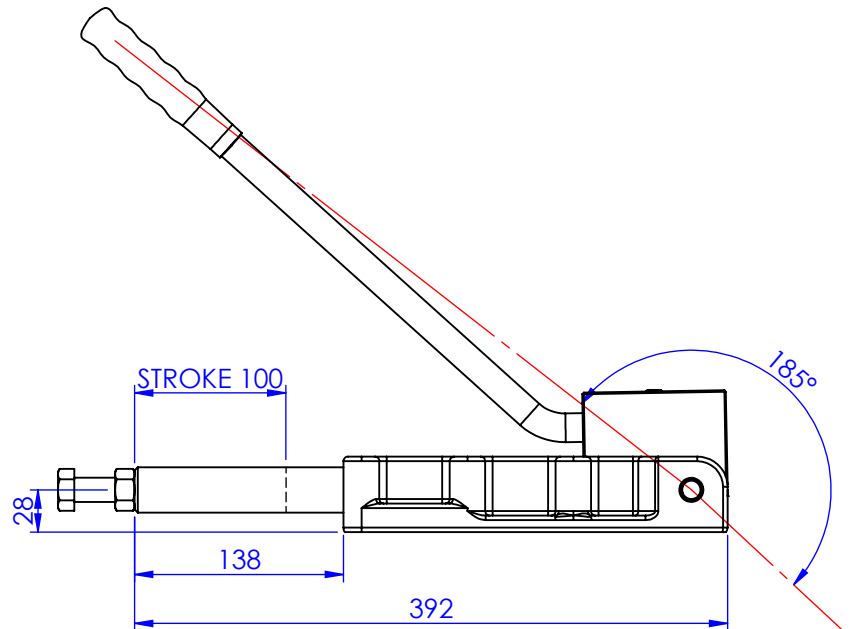
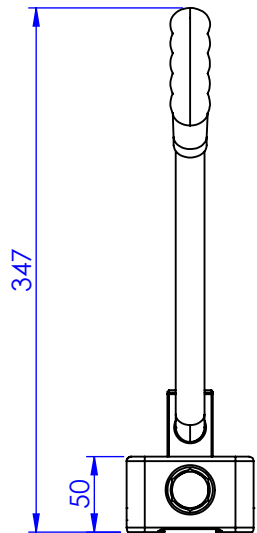
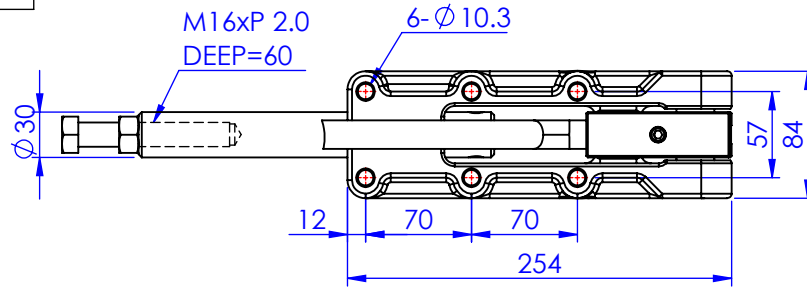

Unit:mm
Scale: 1:5

 **Good Hand Enterprise Co., Ltd**

TITLE:		
DWG NO.	GH-35000HL	A4