

Part No:	GH-32500PR
Holding Capacity:	2500Kg
Plunger Stroke:	75 mm
Handle Opens:	185°
Weight:	17.25Kg
Spindle Supplied:	SA-127517

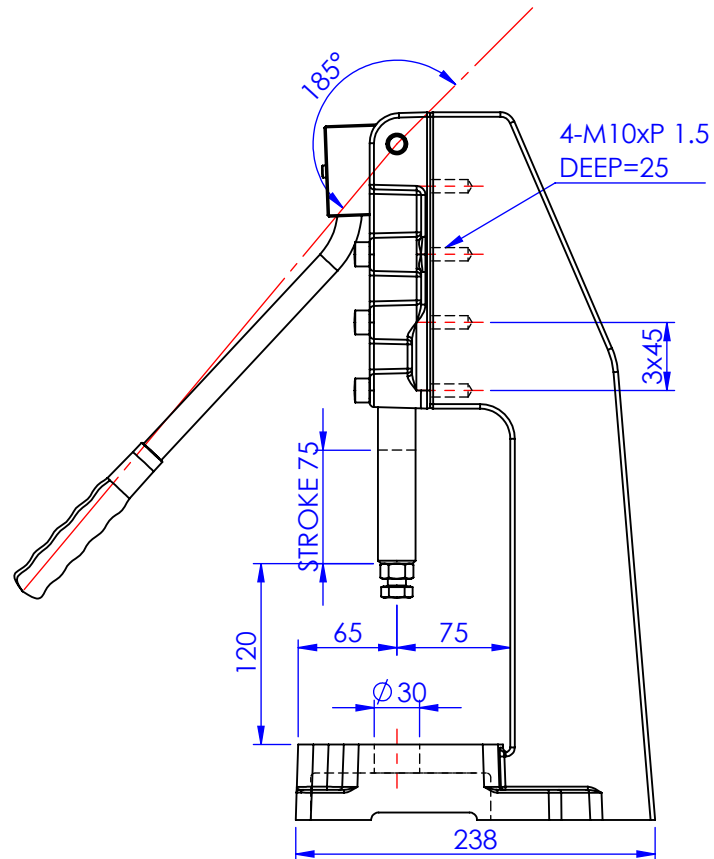
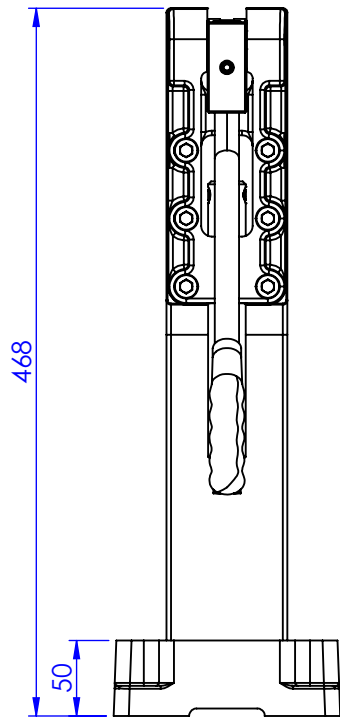
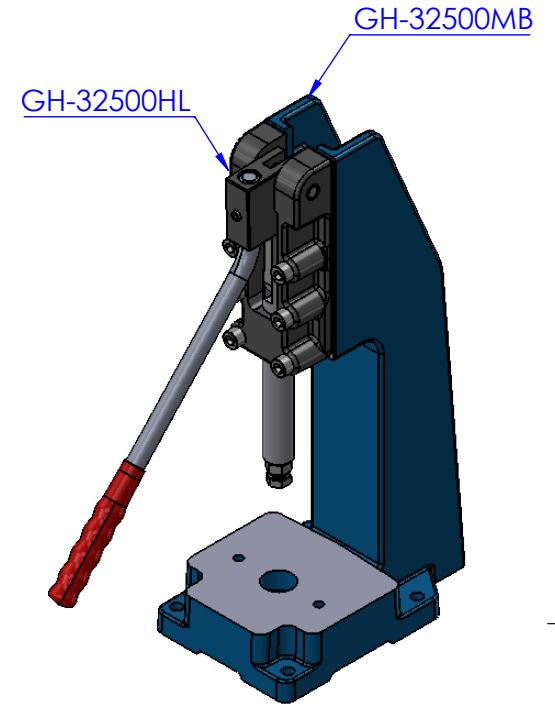
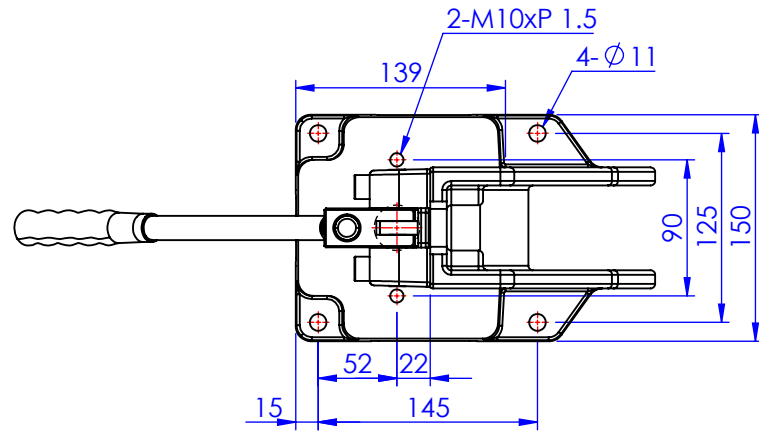

Unit:mm
Scale: 1:5

 **Good Hand Enterprise Co., Ltd**

TITLE:

DWG NO. GH-32500PR A4