

Part No:	GH-32500
Holding Capacity:	2500Kg
Plunger Stroke:	75 mm
Handle Opens:	185°
Weight:	3.89Kg
Spindle Supplied:	SA-127517

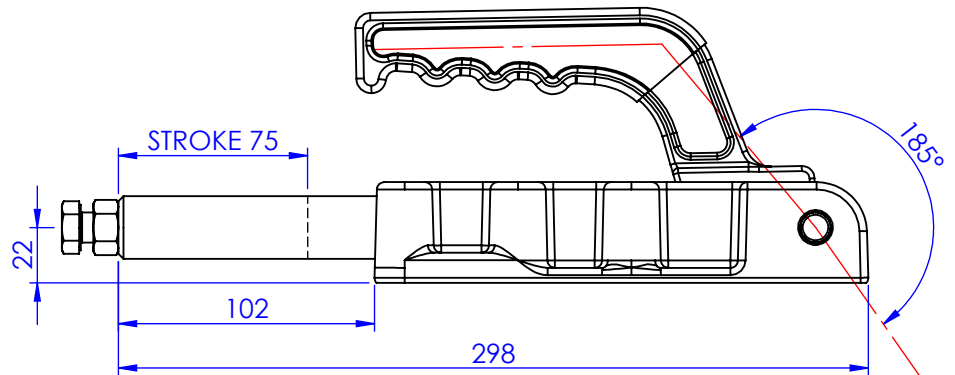
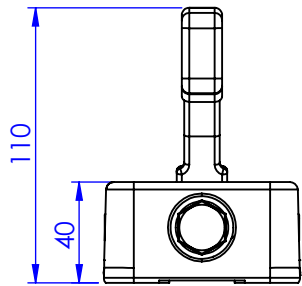
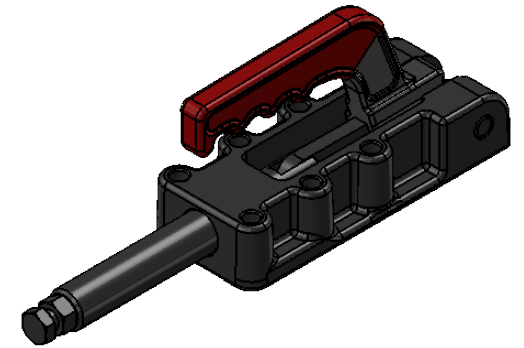
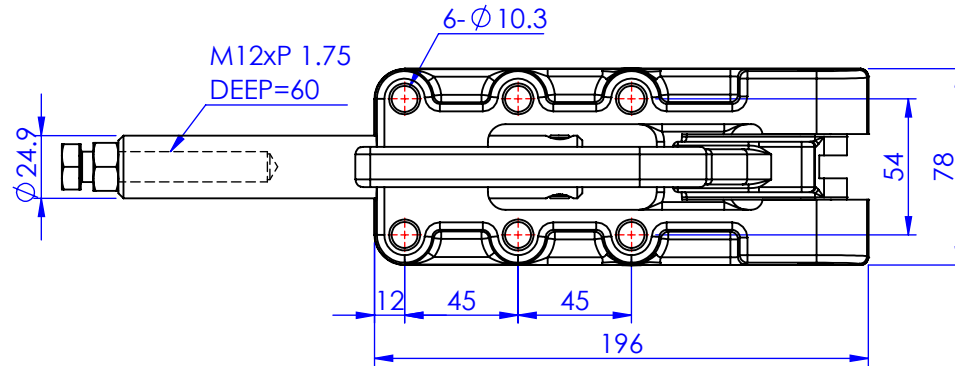

Unit:mm
Scale: 1:3

 **Good Hand Enterprise Co., Ltd**

TITLE:		
DWG NO.	GH-32500	A4