

Part No:	GH-30619M
Holding Capacity:	2273Kg
Plunger Stroke:	77.8 mm
Handle Opens:	183°
Weight:	3.6Kg
Spindle Supplied:	SA-165020

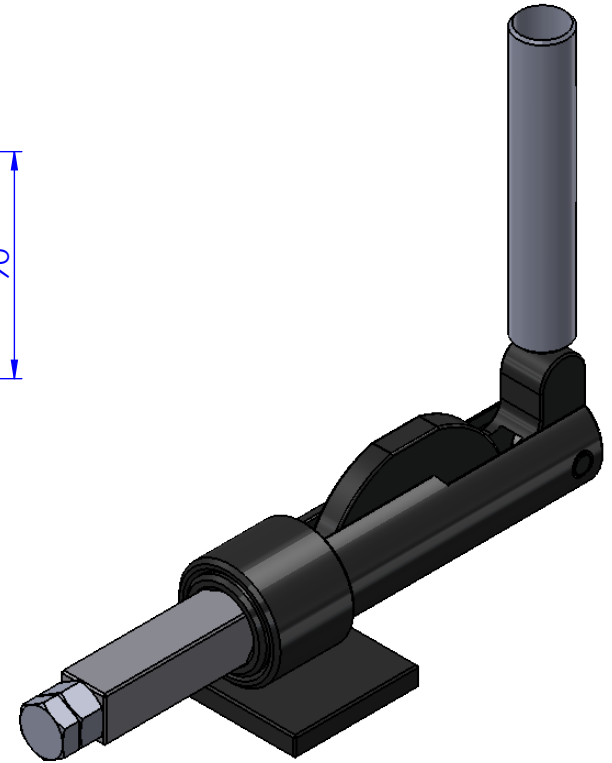
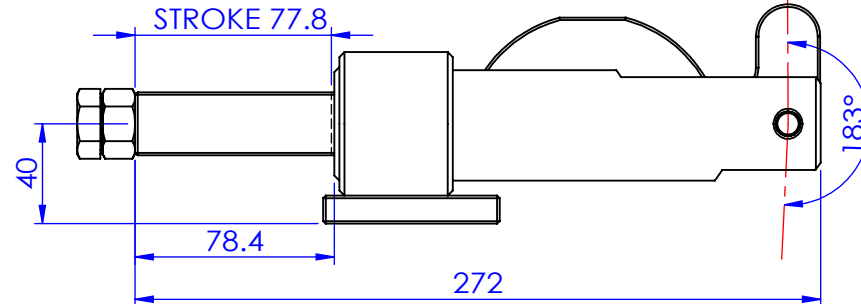
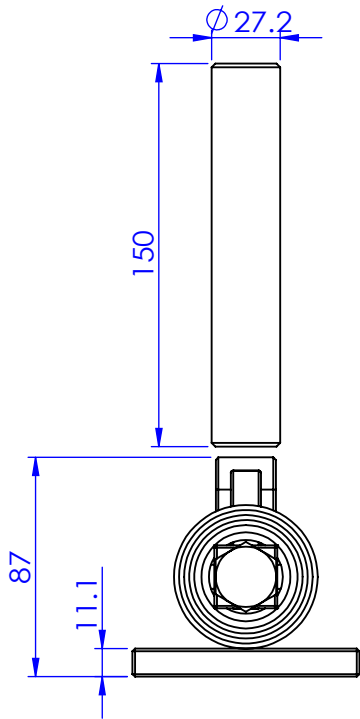
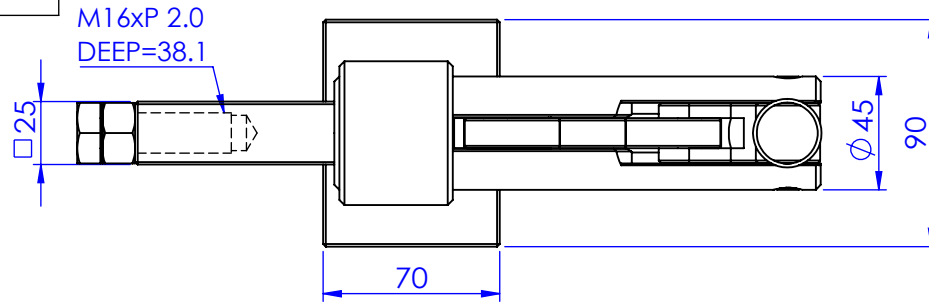

Unit:mm
Scale: 1:3

 **Good Hand Enterprise Co., Ltd**

TITLE:		
DWG NO.	GH-30619M	A4