

Part No:	GH-30608M
Holding Capacity:	318Kg
Plunger Stroke:	41.3 mm
Handle Opens:	180°
Weight:	0.69Kg
Spindle Supplied:	SA-085012

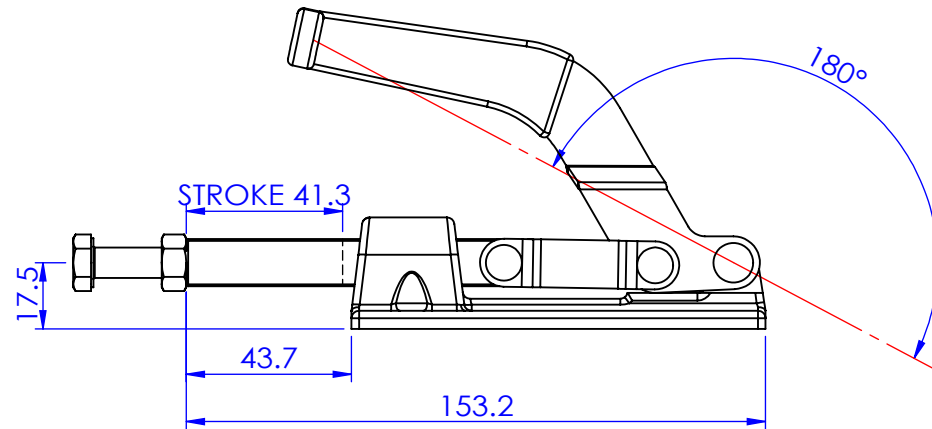

Unit:mm
Scale: 1:2

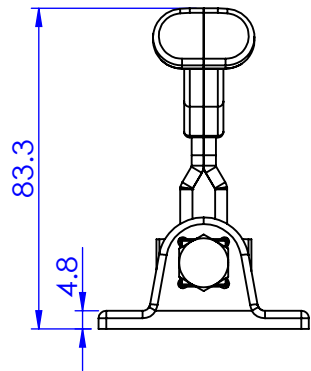
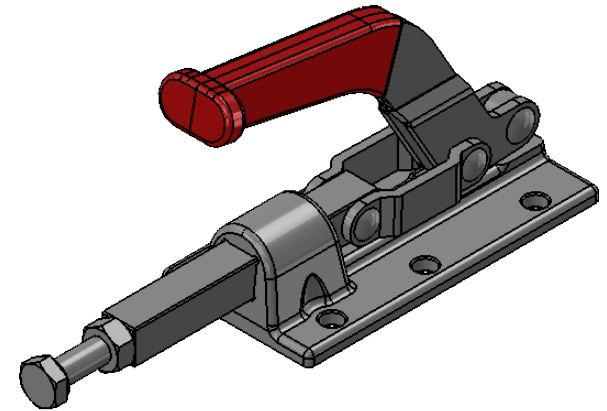
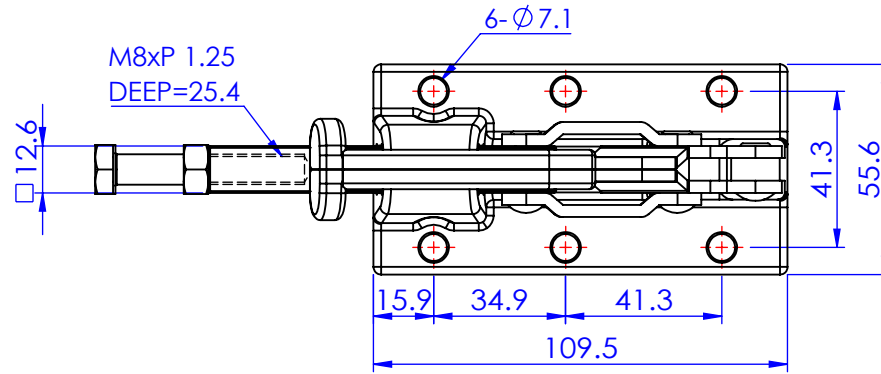

Good Hand Enterprise Co., Ltd

TITLE:

DWG NO.

GH-30608M

A4