

Part No:	GH-30600PR
Holding Capacity:	600Kg
Plunger Stroke:	32 mm
Handle Opens:	185°
Weight:	3.63Kg
Spindle Supplied:	SA-086512

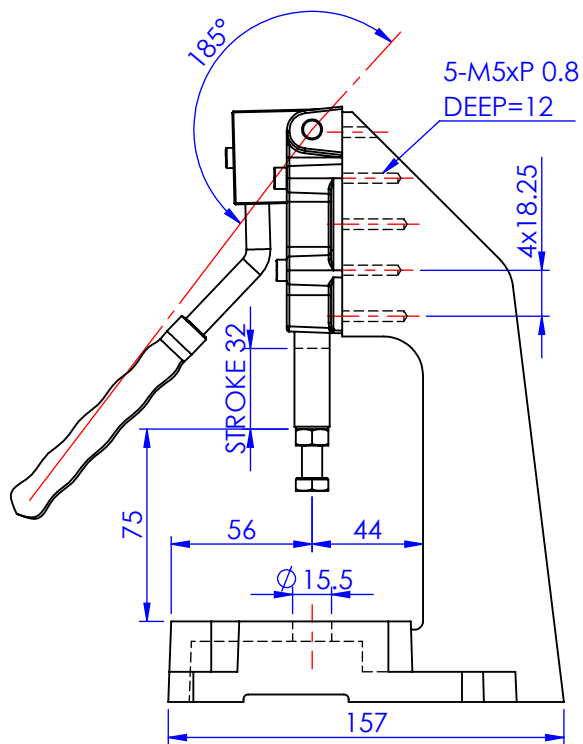
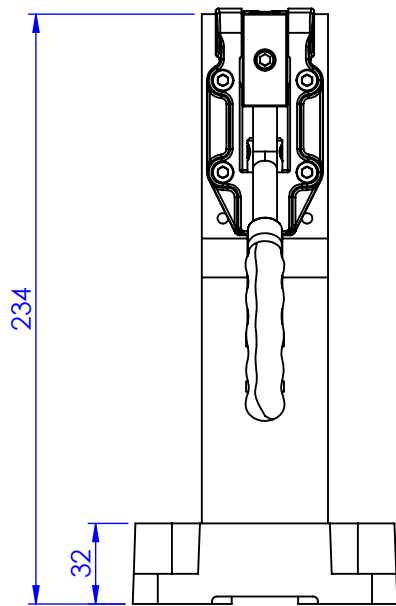
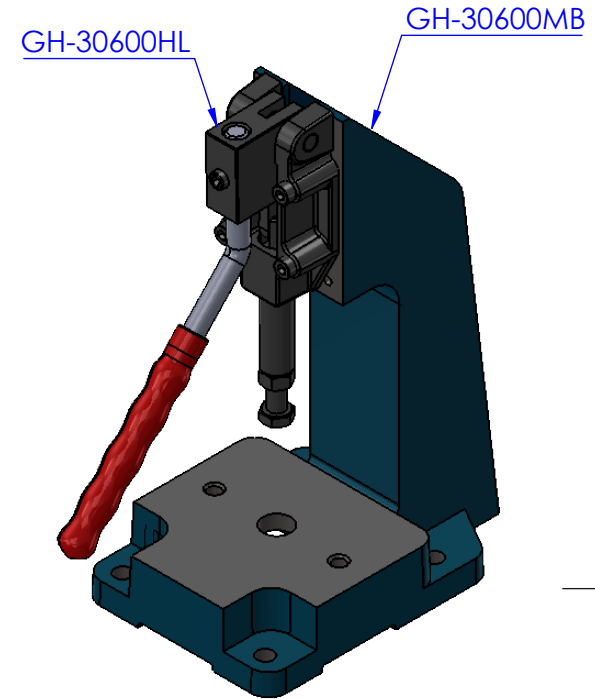
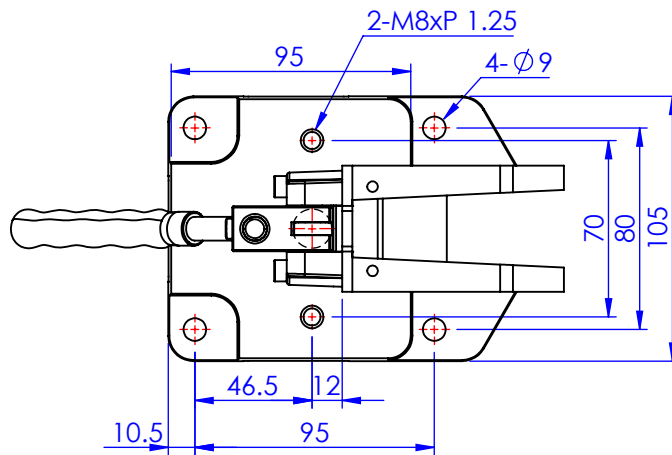

Unit:mm
Scale: 1:3

 **Good Hand Enterprise Co., Ltd**

TITLE:		
DWG NO.	GH-30600PR	A4