

Part No:	GH-305-EM
Holding Capacity:	386Kg
Plunger Stroke:	42 mm
Handle Opens:	183°
Weight:	0.59Kg
Spindle Supplied:	SA-105015

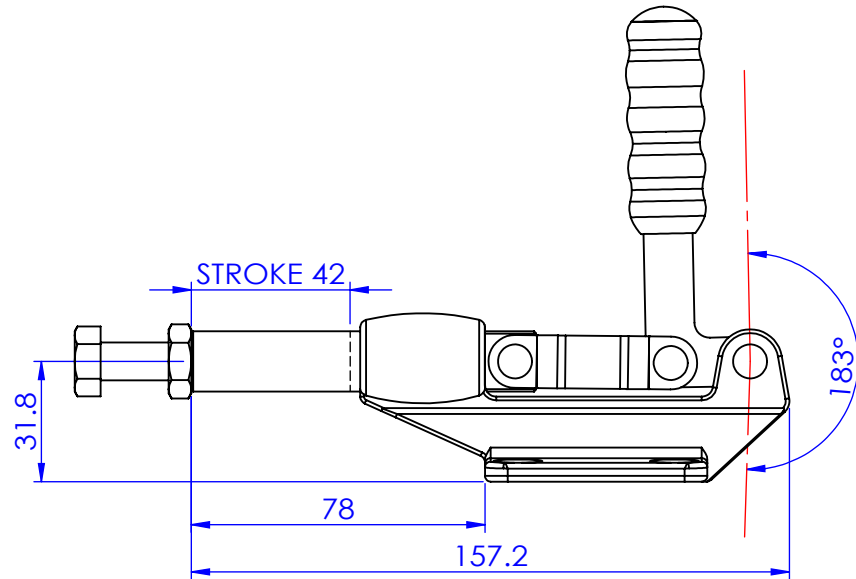
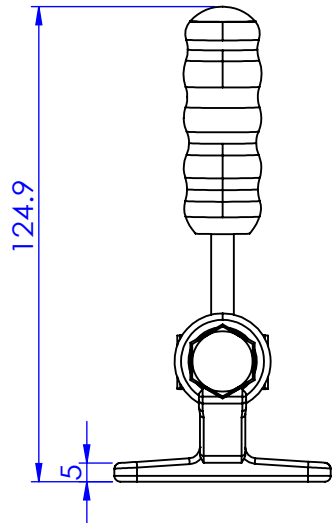
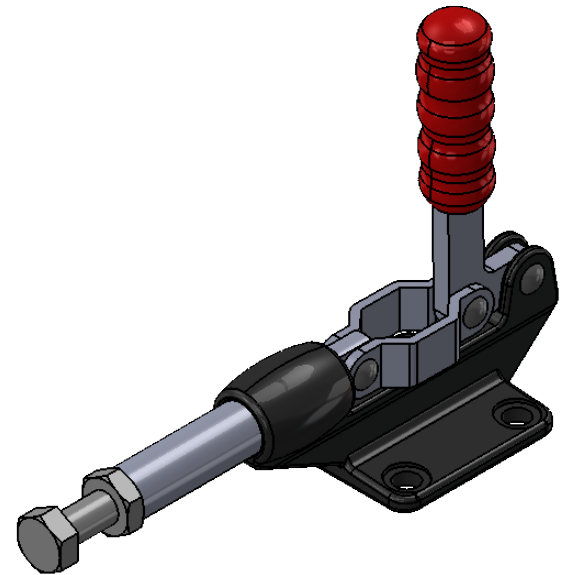
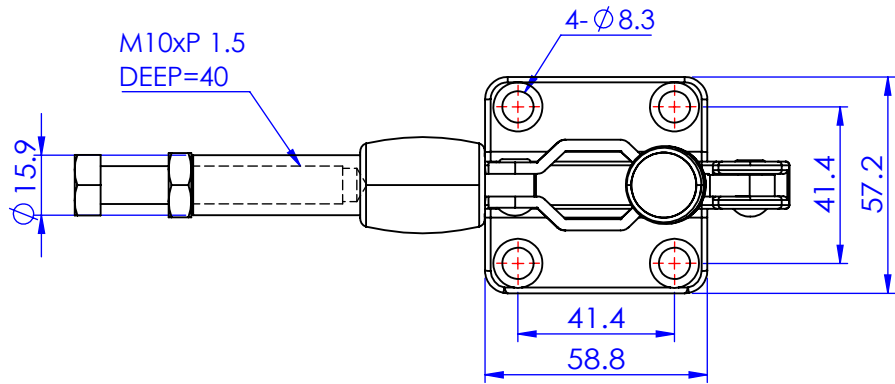

Unit:mm
Scale: 1:2

 **Good Hand Enterprise Co., Ltd**

TITLE:		
DWG NO.	GH-305-EM	A4