

Part No:	GH-25382
Holding Capacity:	280Kg
Bar Opens:	79°
Handle Opens:	87°
Weight:	0.46Kg
Spindle Supplied:	SA-086512
Flanged Washers:	FW-380

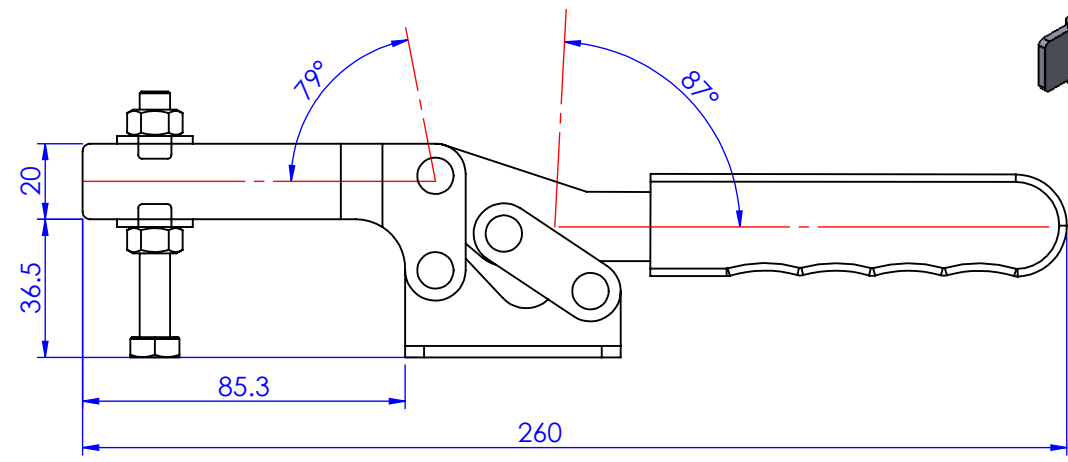
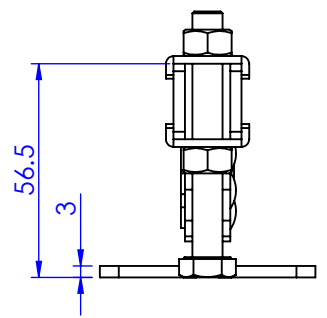
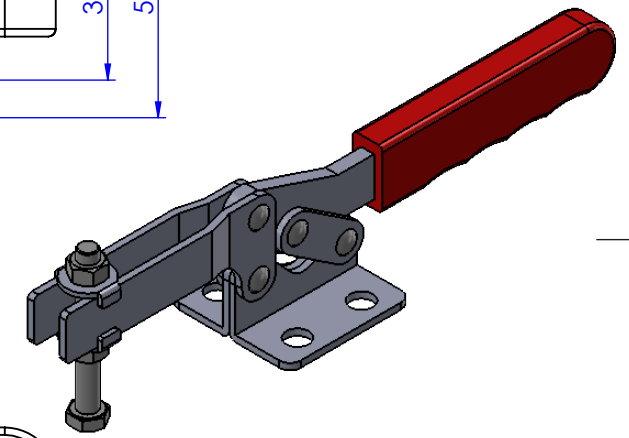
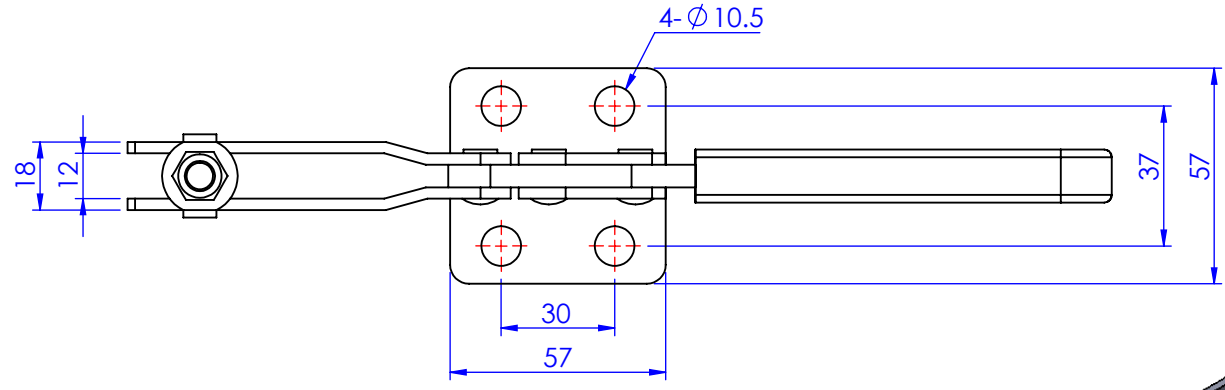

Unit:mm
Scale : 1:2

 **Good Hand Enterprise Co., Ltd**

TITLE:		
DWG NO.	GH-25382	A4