

Part No:	GH-24502-B
Holding Capacity:	450Kg
Bar Opens:	94°
Handle Opens:	80°
Weight:	1.45Kg
Spindle Supplied:	SA-121017
Flanged Washers:	FW-120

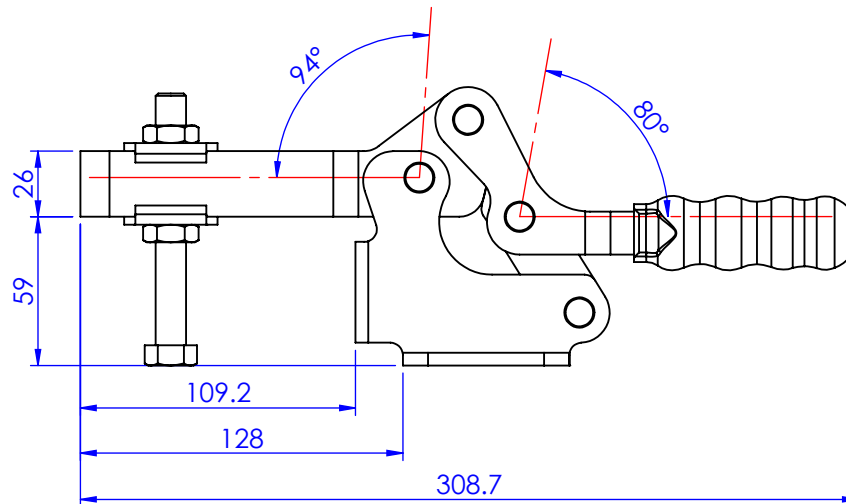
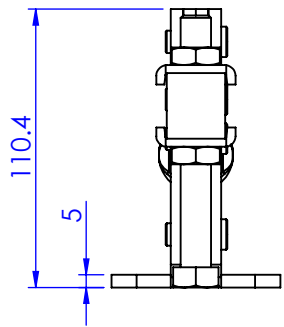
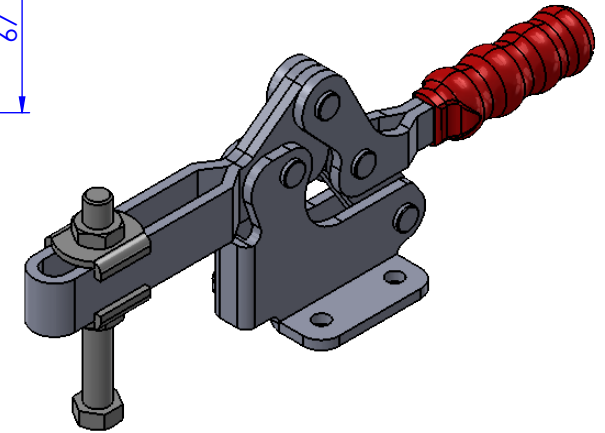
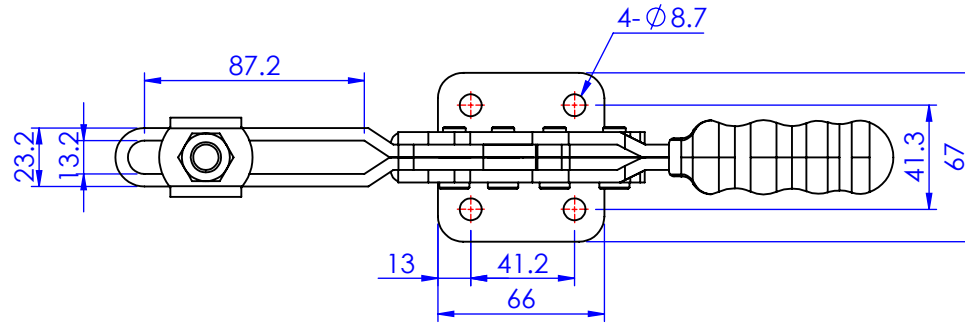

Unit:mm
Scale: 1:3

 **Good Hand Enterprise Co., Ltd**

TITLE:

DWG NO. GH-24502-B A4