

Part No:	GH-225-D
Holding Capacity:	227Kg
Bar Opens:	90°
Handle Opens:	65°
Weight:	0.26Kg
Spindle Supplied:	FC-086312
Flanged Washers:	FW-516

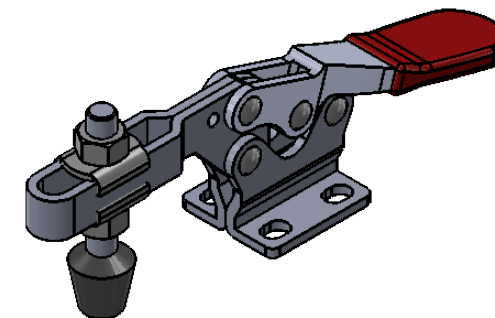
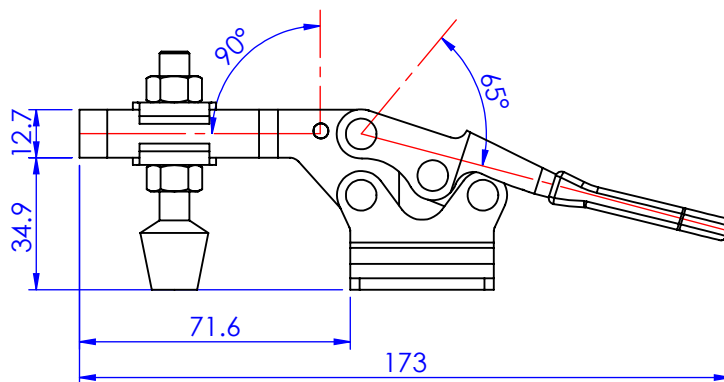
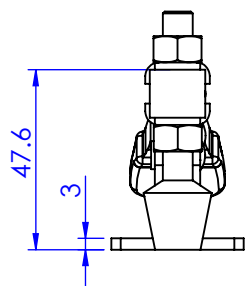
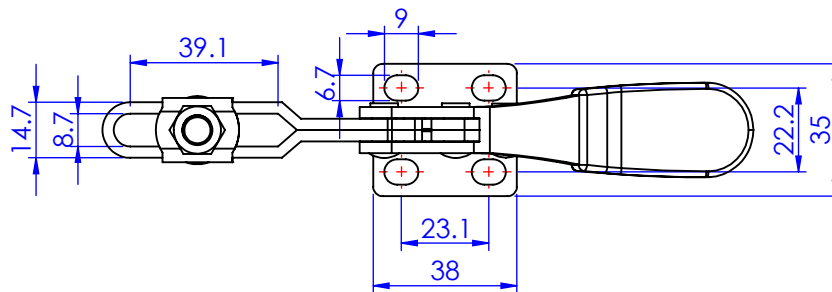

Unit:mm
Scale: 1:2

 **Good Hand Enterprise Co., Ltd**

TITLE:

DWG NO. GH-225-D A4