

Part No:	GH-22245
Holding Capacity:	273Kg
Bar Opens:	90°
Handle Opens :	84°
Weight:	0.64Kg
Spindle Supplied:	FC-087512
Bolt Retainer:	BR-516

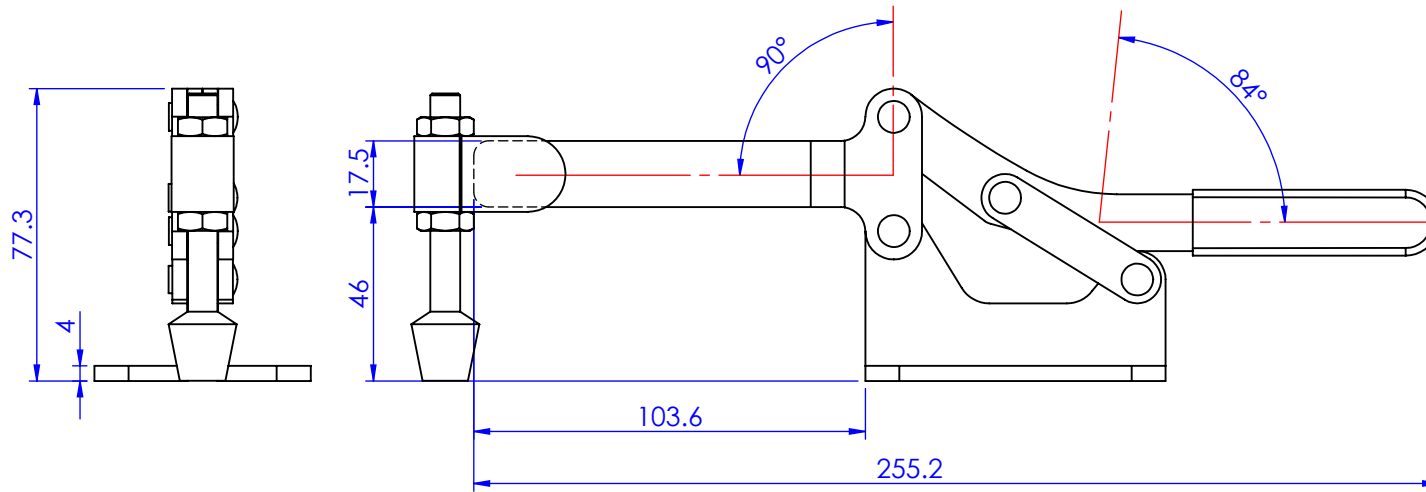
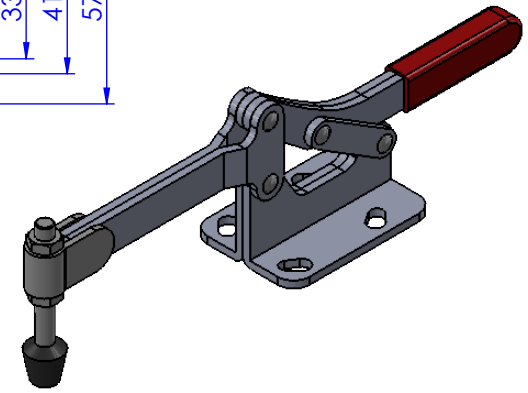
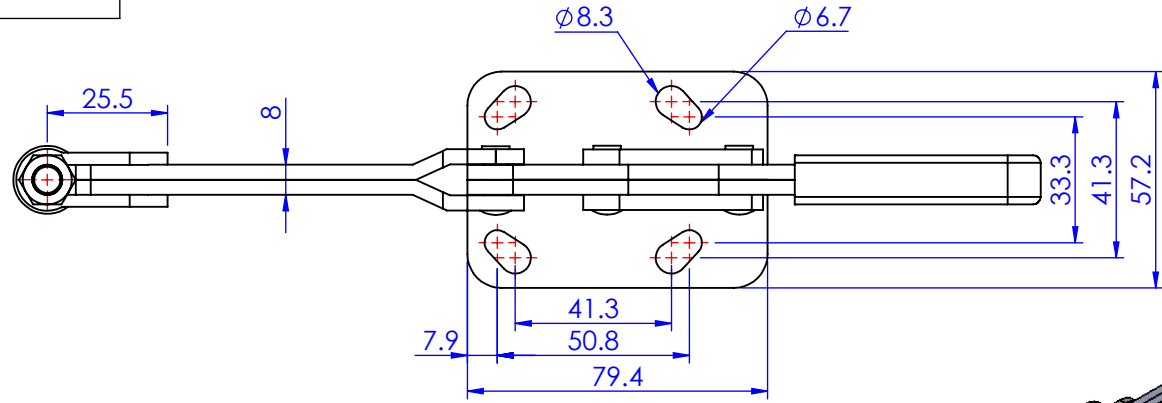

Unit:mm  
Scale : 1:2

 **Good Hand Enterprise Co., Ltd**

TITLE:		
DWG NO.	GH-22245	A4