

Part No:	GH-22235
Holding Capacity:	273Kg
Bar Opens:	90°
Handle Opens :	84°
Weight:	0.63Kg
Spindle Supplied:	FC-087515
Flanged Washers:	FW-516

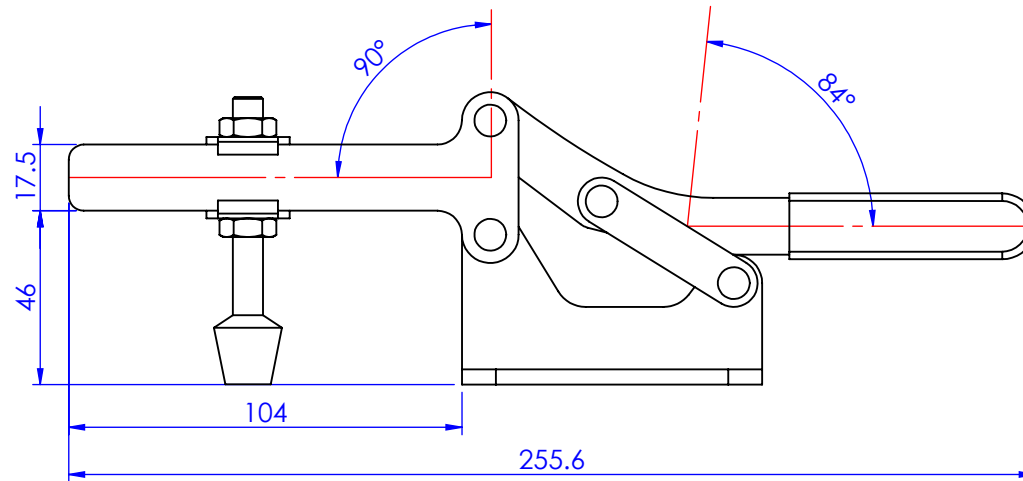
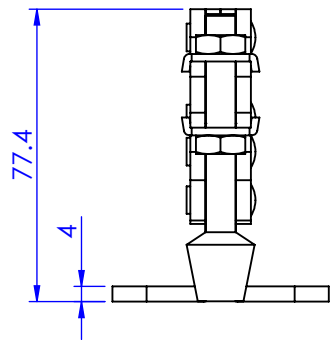
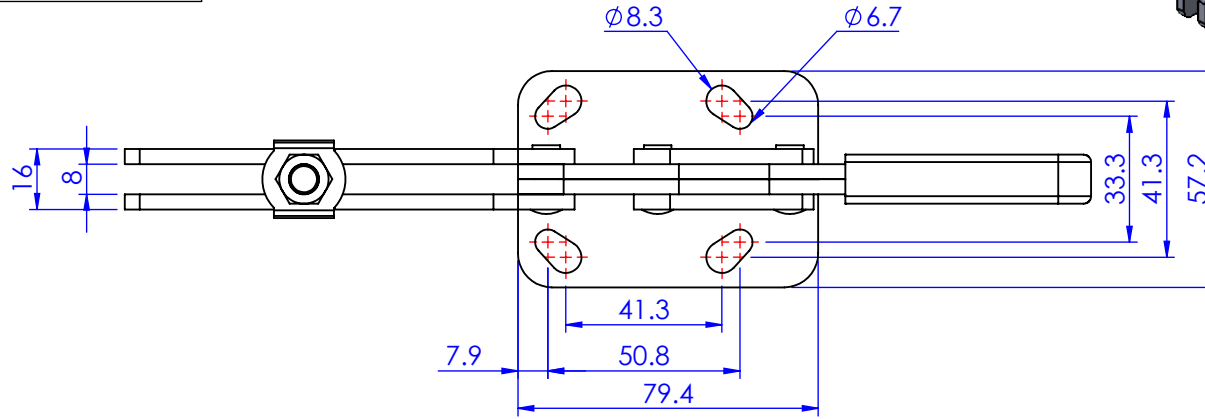
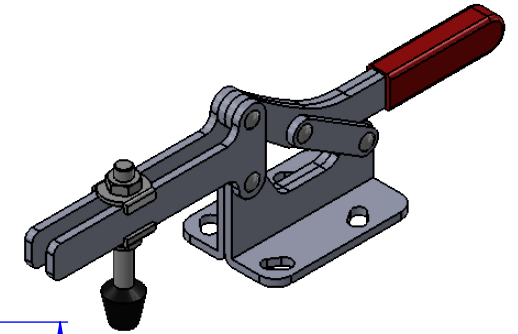

Unit:mm
Scale : 1:2

 **Good Hand Enterprise Co., Ltd**

TITLE:		
DWG NO.	GH-22235	A4