

Part No:	GH-22195
Holding Capacity:	250Kg
Bar Opens:	93°
Handle Opens:	88°
Weight:	0.36Kg
Spindle Supplied:	FC-086312
Bolt Retainer:	BR-516

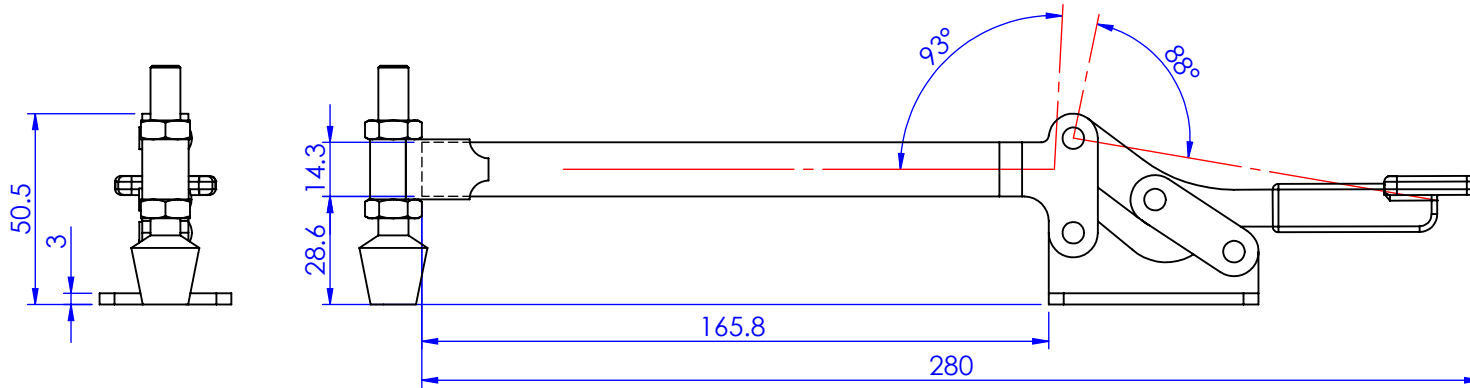
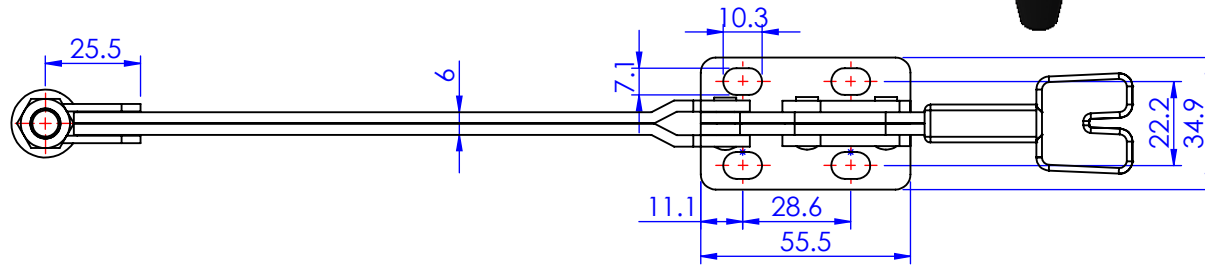
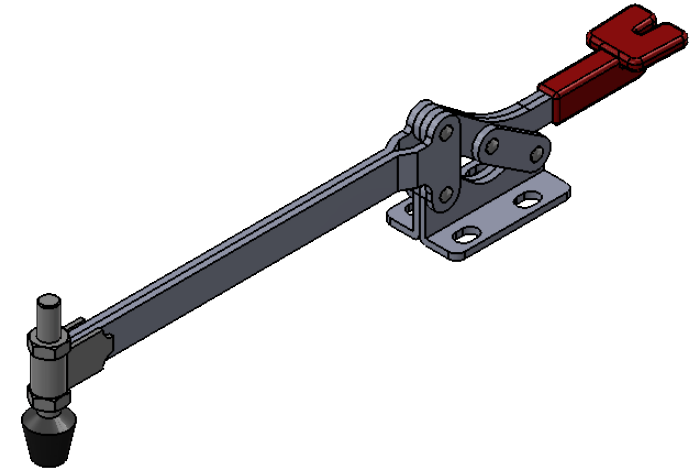

Unit:mm
Scale : 1:2

 **Good Hand Enterprise Co., Ltd**

TITLE:		
DWG NO.	GH-22195	A4