

Part No:	GH-22185
Holding Capacity:	250Kg
Bar Opens:	93°
Handle Opens:	88°
Weight:	0.33Kg
Spindle Supplied:	FC-086312
Flanged Washers:	FW-516

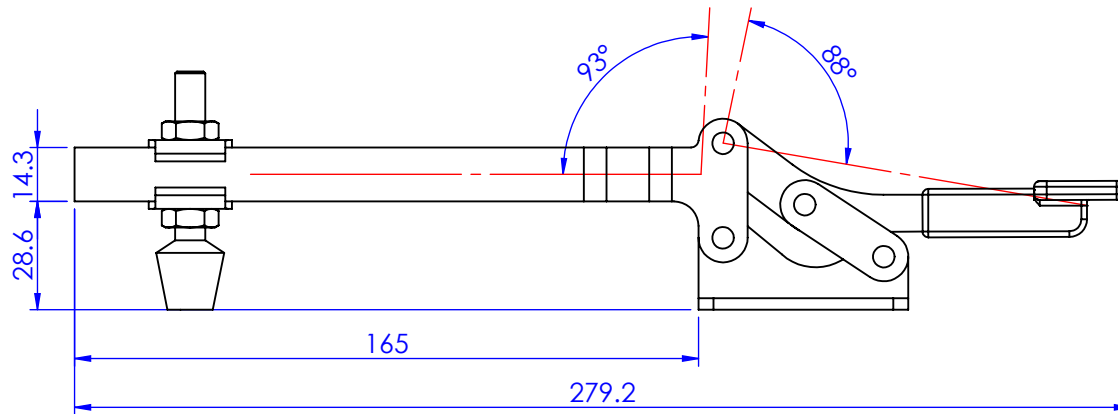
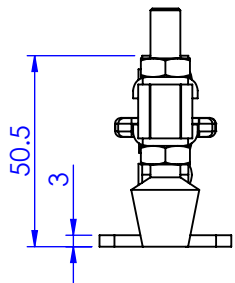
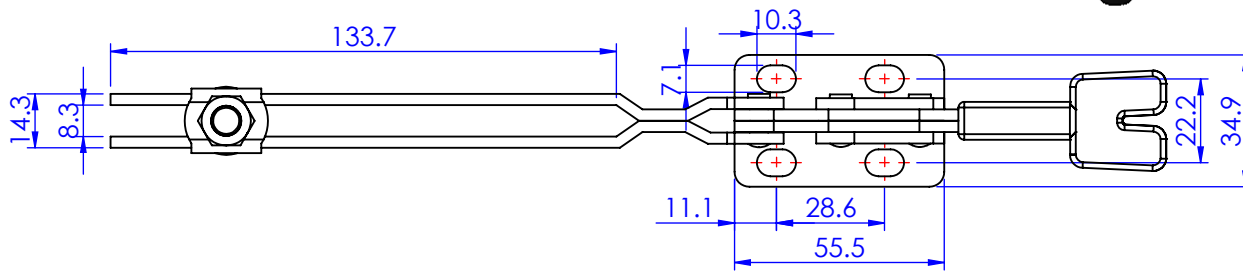
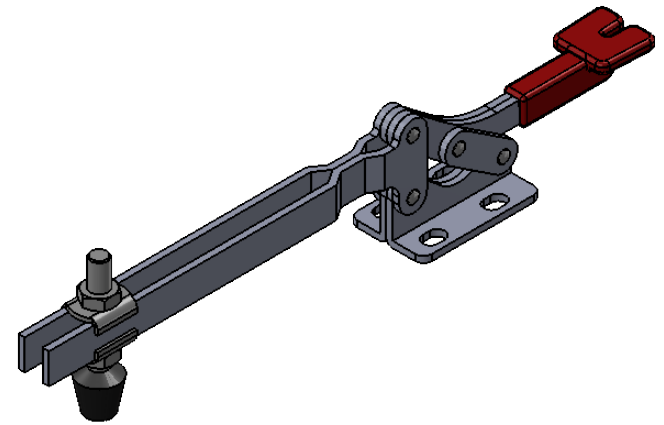

Unit:mm

Scale: 1:2

 **Good Hand Enterprise Co., Ltd**

TITLE:

DWG NO. GH-22185

A4