

Part No:	GH-22165
Holding Capacity:	250Kg
Bar Opens:	93°
Handle Opens:	88°
Weight:	0.28Kg
Spindle Supplied:	FC-086312
Flanged Washers:	FW-516

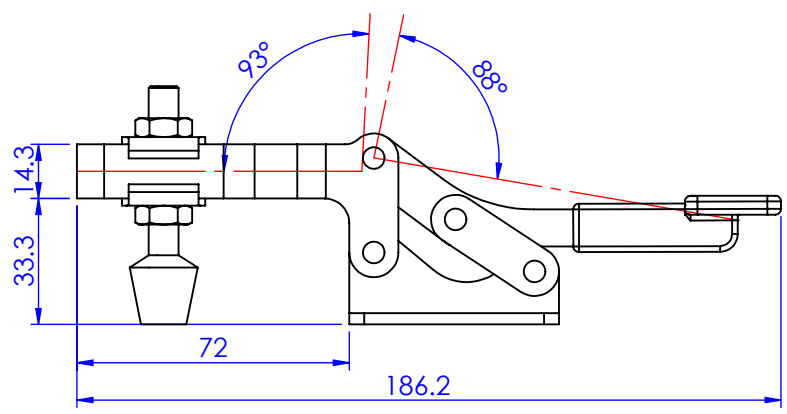
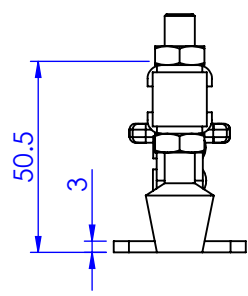
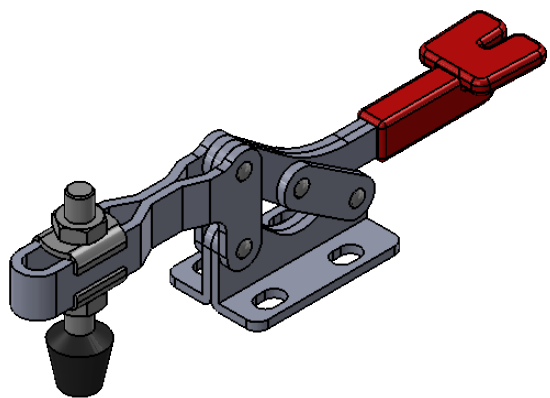
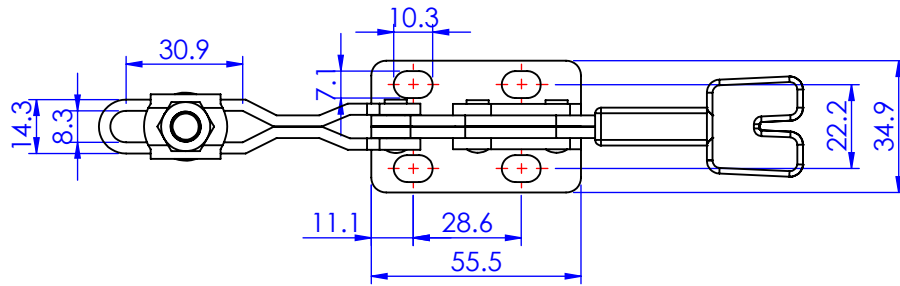

Unit:mm
Scale: 1:2

 **Good Hand Enterprise Co., Ltd**

TITLE:		
DWG NO.	GH-22165	A4