

Part No:	GH-22110
Holding Capacity:	68Kg
Bar Opens:	83°
Handle Opens:	70°
Weight:	0.11Kg
Spindle Supplied:	FC-064410
Bolt Retainer:	BR-140

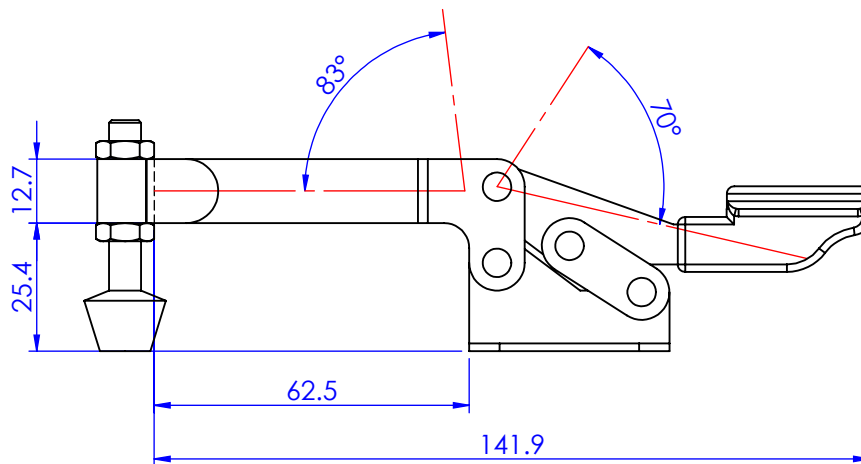
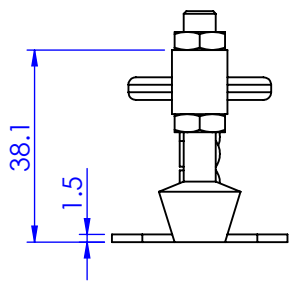
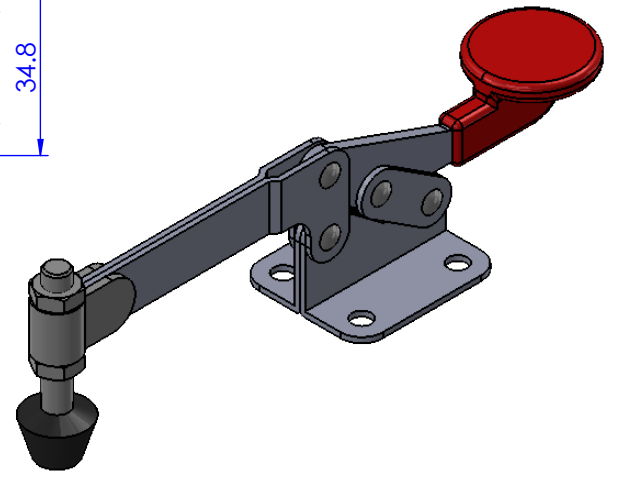
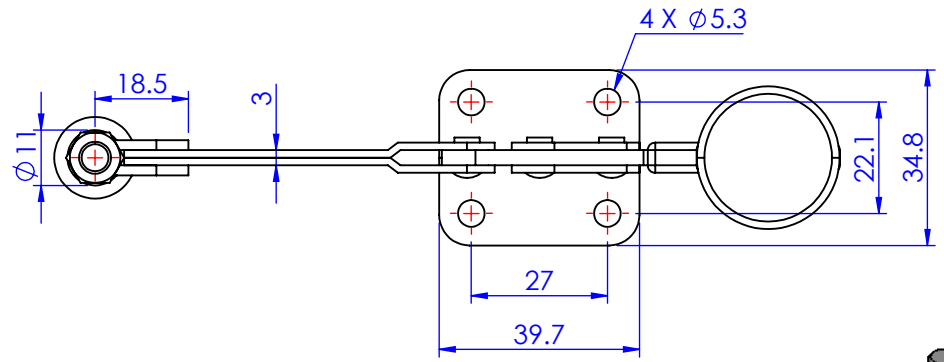

Unit:mm
Scale: 1:1.5

 **Good Hand Enterprise Co., Ltd**

TITLE:		
DWG NO.	GH-22110	A4