

Part No:	GH-22100
Holding Capacity:	68Kg
Bar Opens:	83°
Handle Opens:	70°
Weight:	0.11Kg
Spindle Supplied:	FC-064410
Flanged Washers:	FW-140

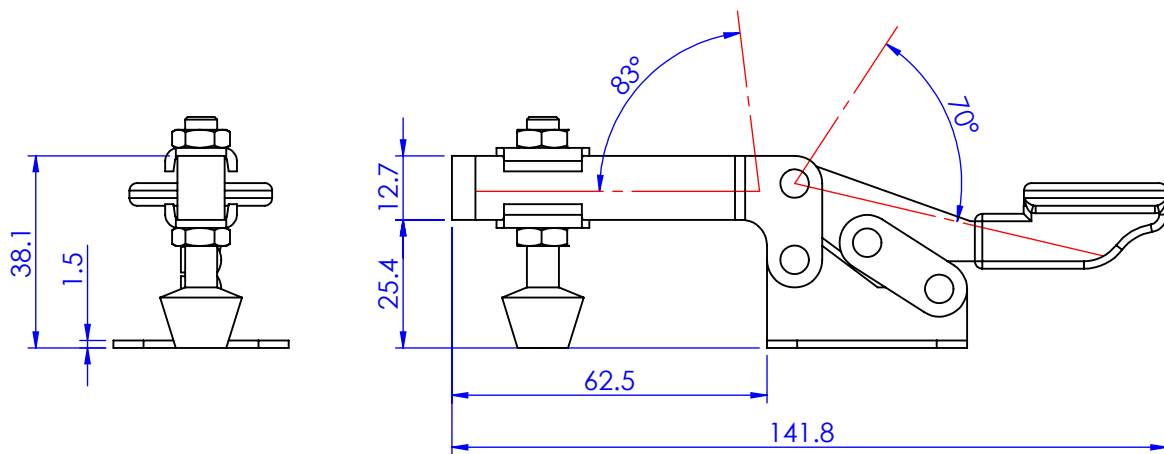

Unit:mm  
Scale: 1:1.5

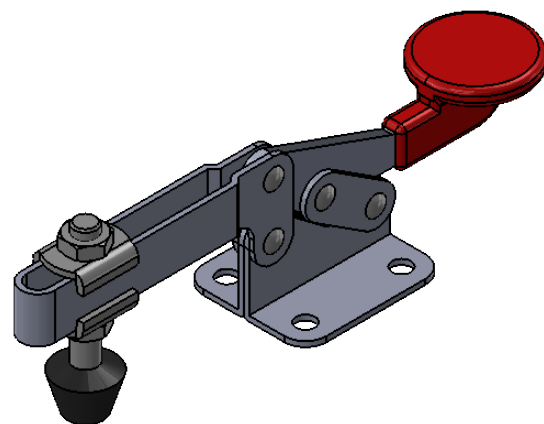
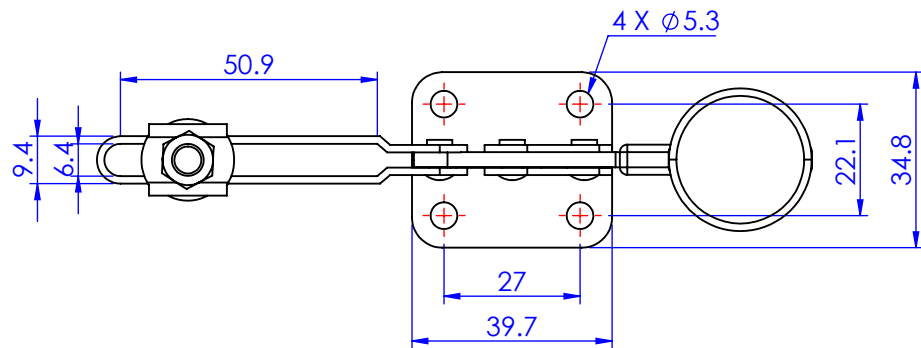

**Good Hand Enterprise Co., Ltd**

TITLE:

DWG NO.

GH-22100

A4