

Part No:	GH-22025
Holding Capacity:	22.7Kg
Bar Opens:	90°
Handle Opens:	69°
Weight:	0.03Kg
Spindle Supplied:	SA-042007(NYLON)

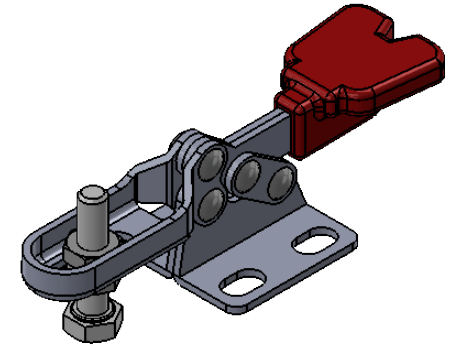
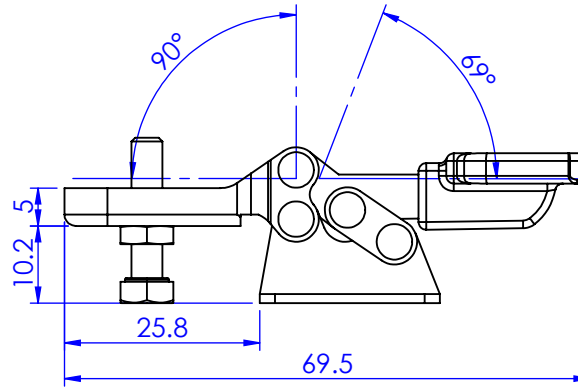
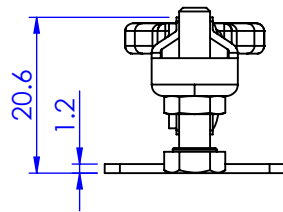
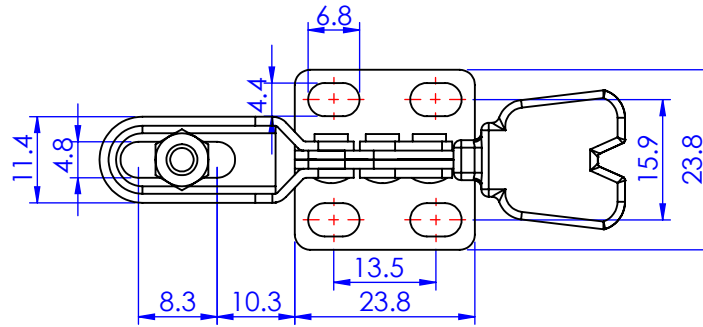

Unit:mm

Scale: 1:1

 **Good Hand Enterprise Co., Ltd**

TITLE:

DWG NO. GH-22025 A4