

Part No:	GH-22020
Holding Capacity:	22.7Kg
Bar Opens:	90°
Handle Opens:	69°
Weight:	0.03Kg
Spindle Supplied:	SA-042007(NYLON)

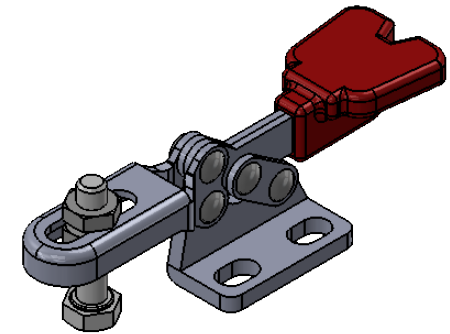
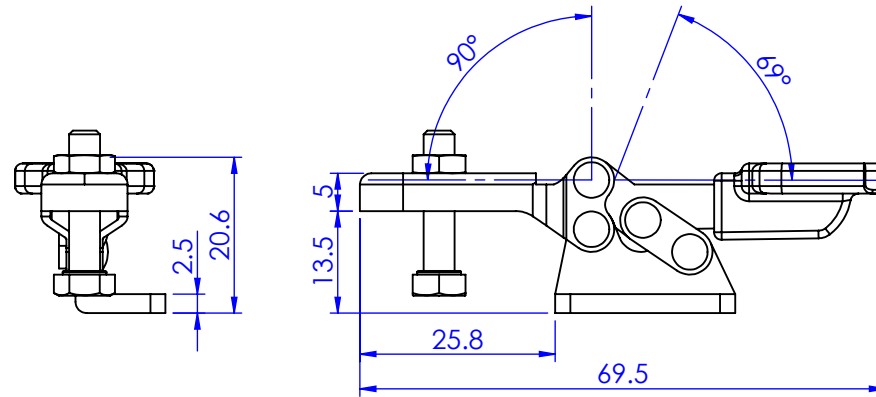
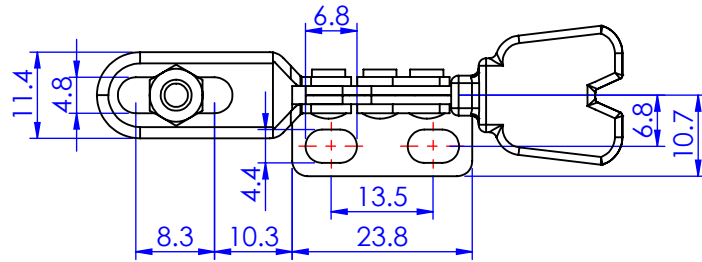

Unit:mm
Scale: 1:1

 **Good Hand Enterprise Co., Ltd**

TITLE:		
DWG NO.	GH-22020	A4