

Part No:	GH-21384
Holding Capacity:	500Kg
Bar Opens:	66°
Handle Opens:	83°
Weight:	0.74Kg
Spindle Supplied:	SA-106515
Flanged Washers:	FW-121

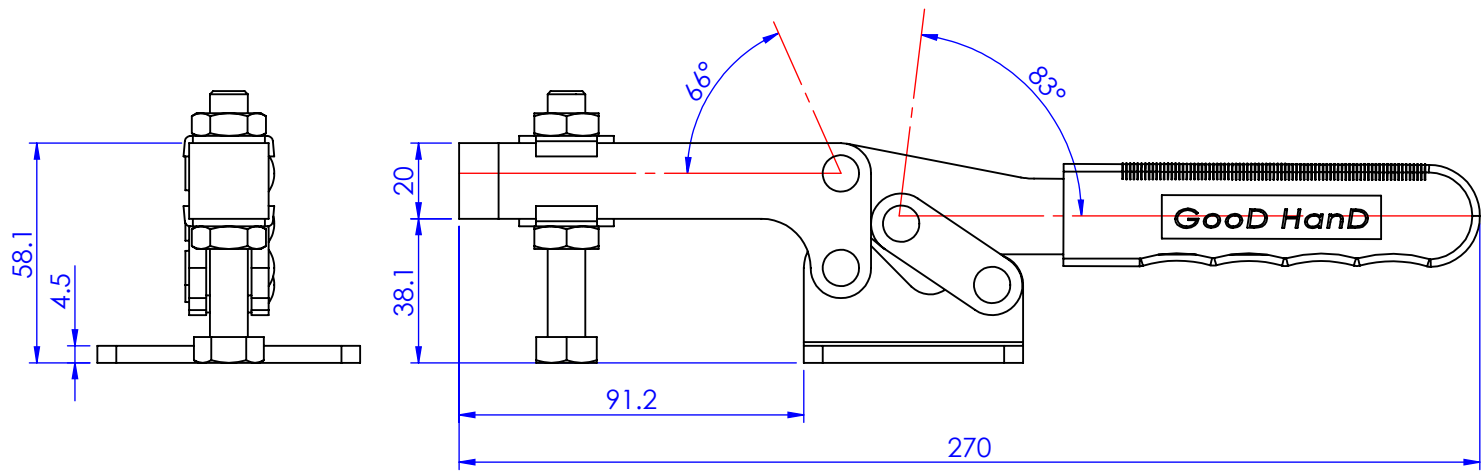
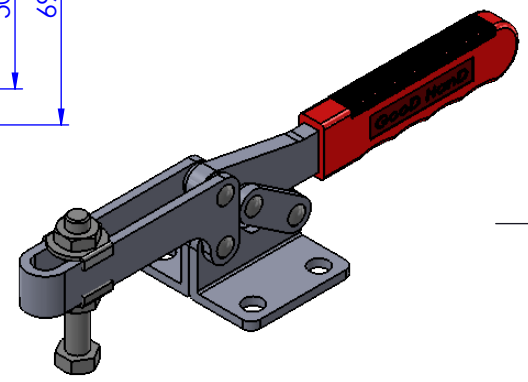
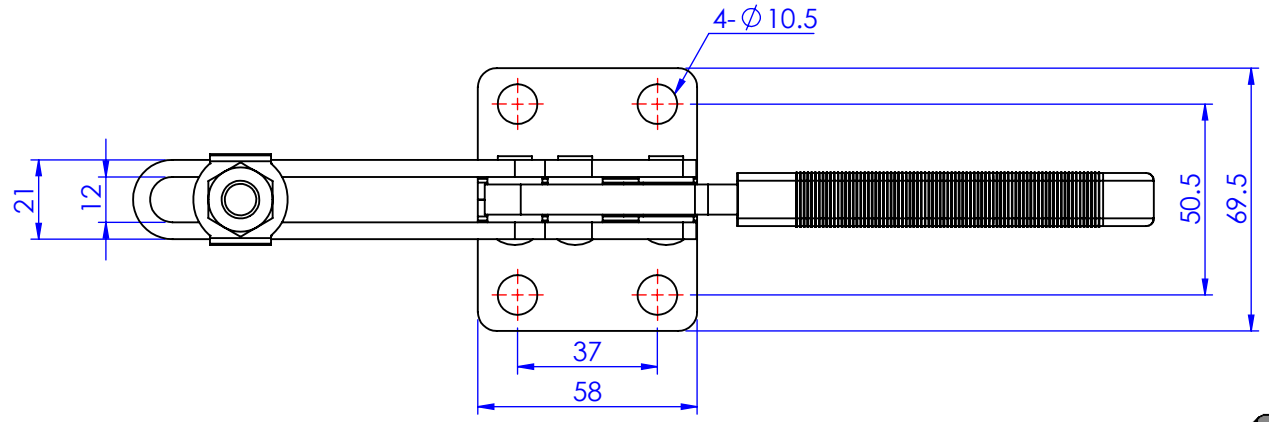

Unit:mm  
Scale : 1:2

 **Good Hand Enterprise Co., Ltd**

TITLE:

DWG NO. GH-21384

A4