

Part No:	GH-21382-SS
Holding Capacity:	250Kg
Bar Opens:	77°
Handle Opens:	85°
Weight:	0.22Kg
Spindle Supplied:	SA-065010-SS
Flanged Washers:	FW-516-SS

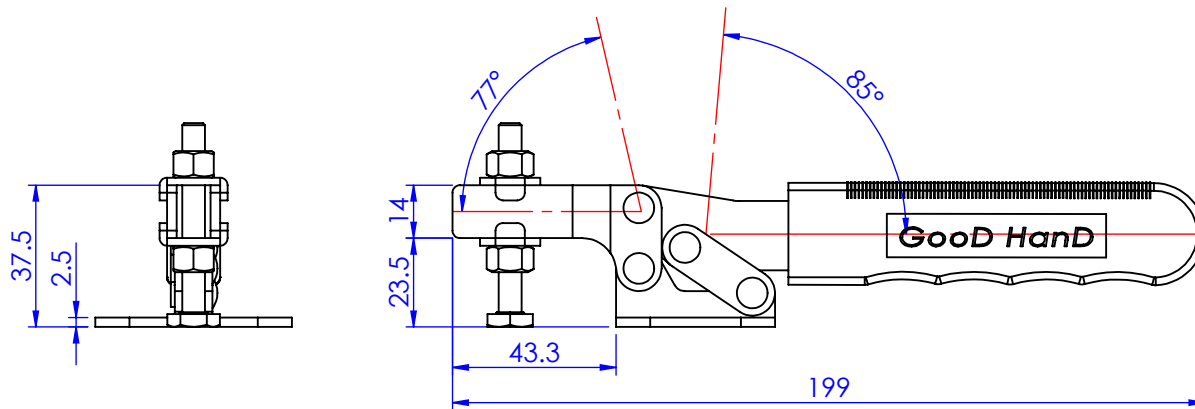
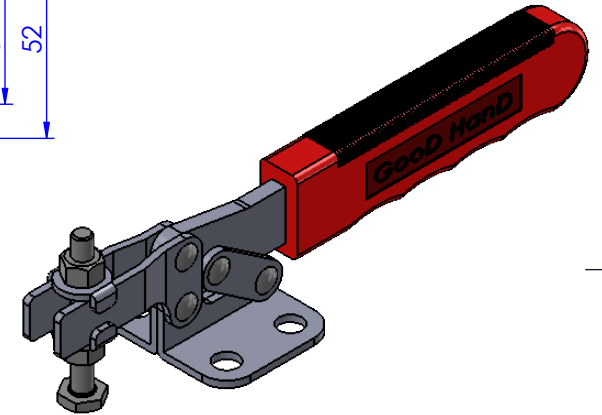
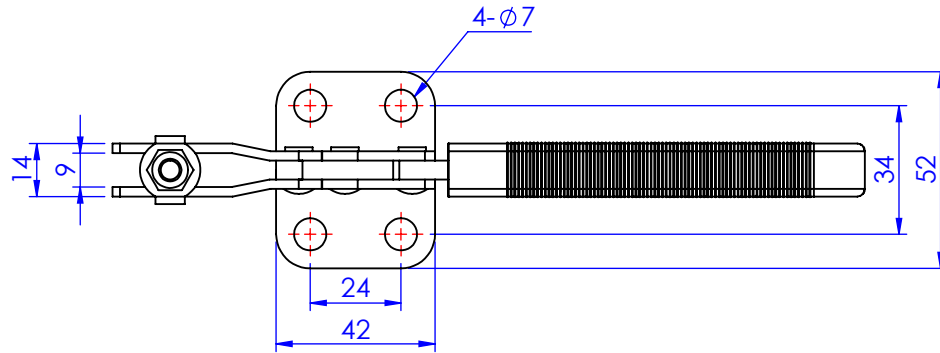

Unit:mm
Scale : 1:2

 **Good Hand Enterprise Co., Ltd**

TITLE:		
DWG NO.	GH-21382-SS	A4