

Part No:	GH-20400
Holding Capacity:	20Kg
Bar Opens:	75°
Handle Opens:	82°
Weight:	0.04Kg
Spindle Supplied:	SA-042507
Flanged Washers:	FW-080

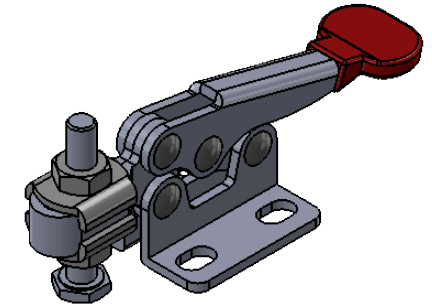
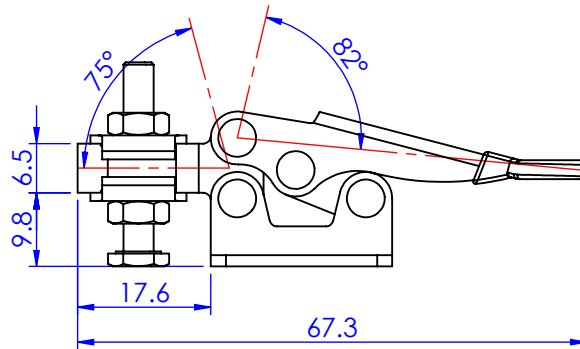
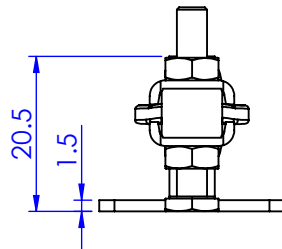
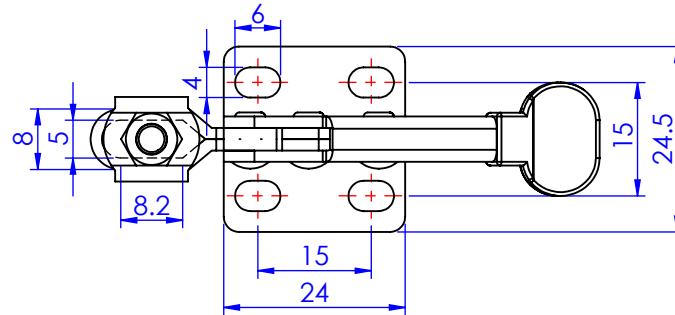

Unit:mm
Scale : 1:1

 **Good Hand Enterprise Co., Ltd**

TITLE:

DWG NO. GH-20400

A4