

Part No:	GH-20300
Holding Capacity:	30Kg
Bar Opens:	72°
Handle Opens:	74°
Weight:	0.1Kg
Spindle Supplied:	SA-044007
Flanged Washers:	FW-100

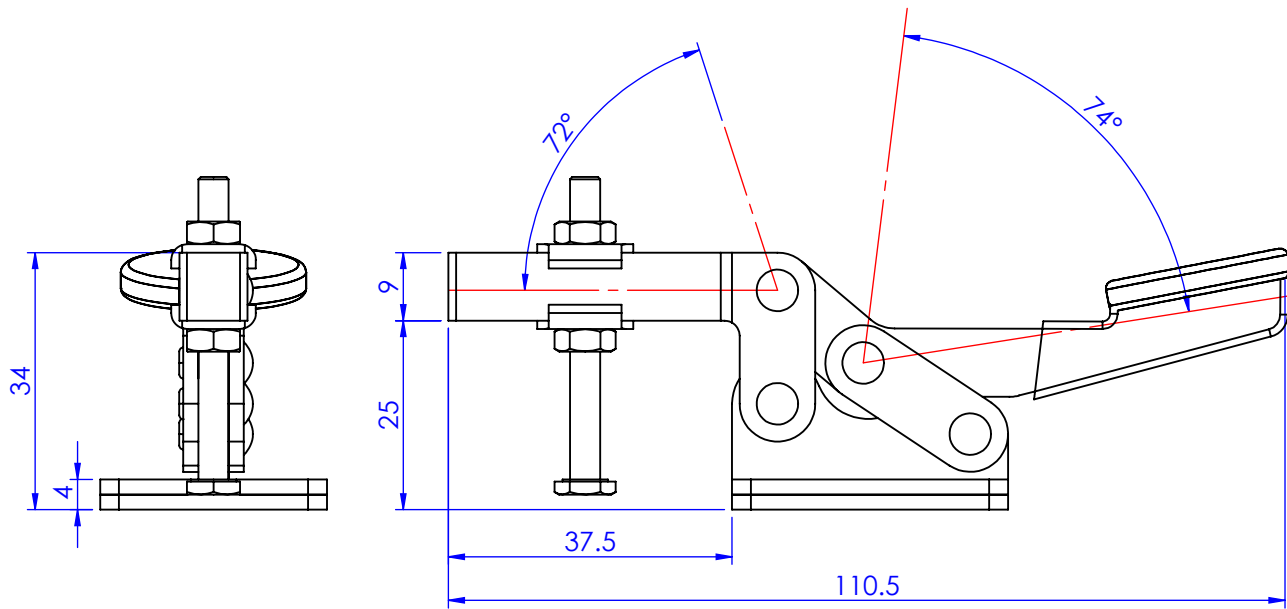
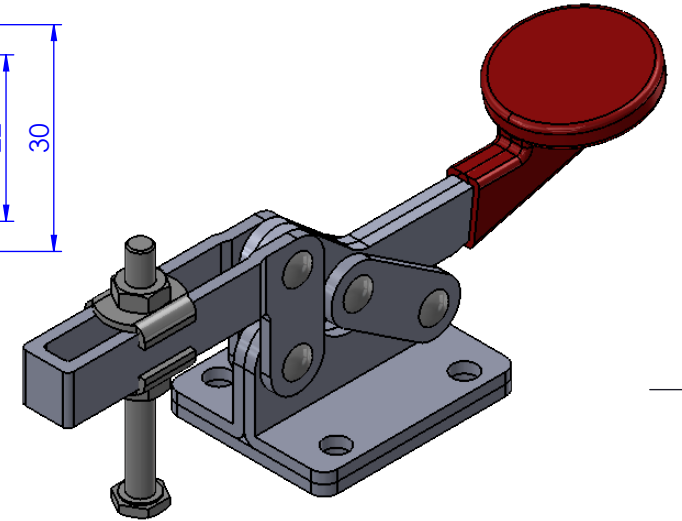
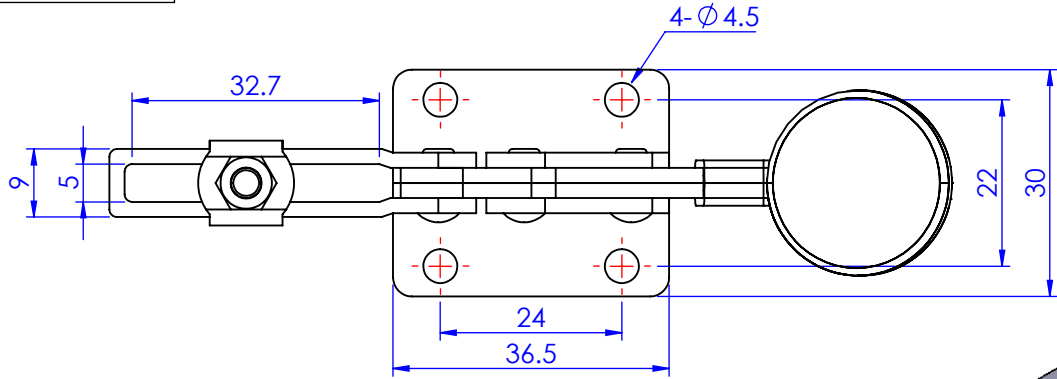

Unit:mm  
Scale : 1:1

 **Good Hand Enterprise Co., Ltd**

TITLE:		
DWG NO.	GH-20300	A4