

Part No:	GH-20235-SS
Holding Capacity:	340Kg
Bar Opens:	90°
Handle Opens:	68°
Weight:	0.61Kg
Spindle Supplied:	SA-107515-SS
Flanged Washers:	FW-380-SS

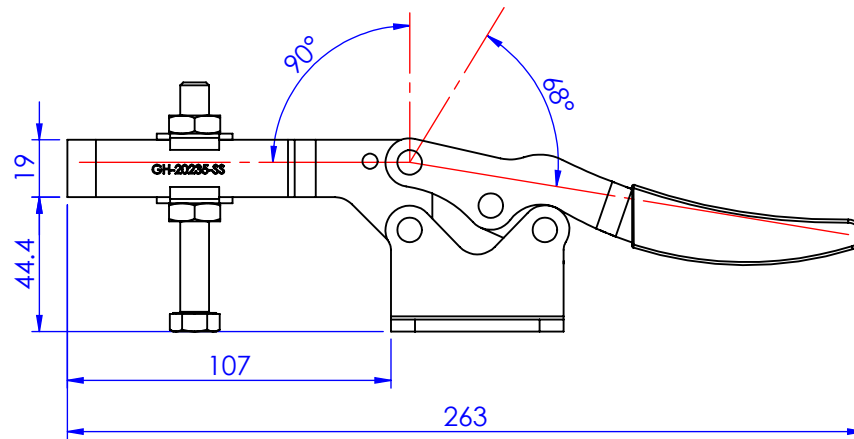
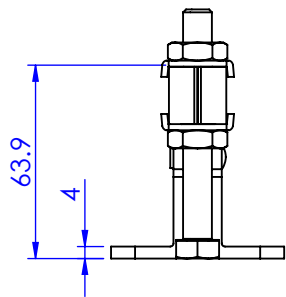
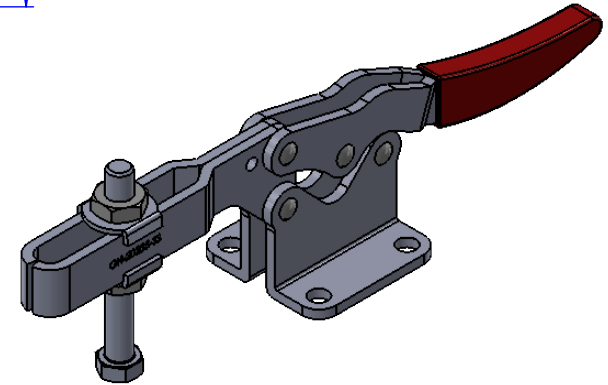
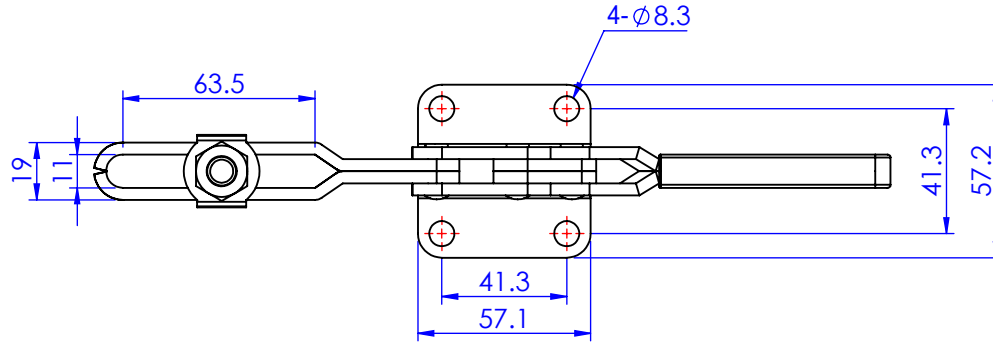

Unit:mm
Scale : 1:2.5

 **Good Hand Enterprise Co., Ltd**

TITLE:		
DWG NO.	GH-20235-SS	A4