

Part No:	GH-201-SS
Holding Capacity:	27Kg
Bar Opens:	90°
Handle Opens:	75°
Weight:	0.03Kg
Spindle Supplied:	SA-042007-SS
Flanged Washers:	FW-080-SS

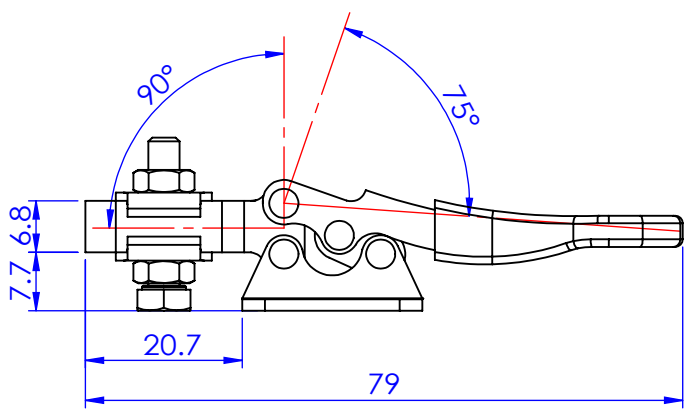
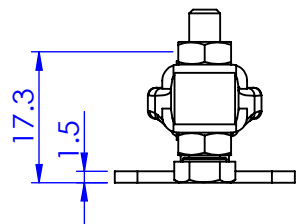
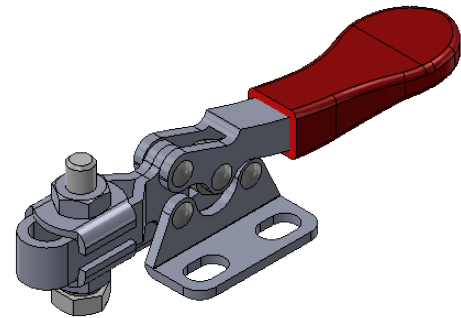
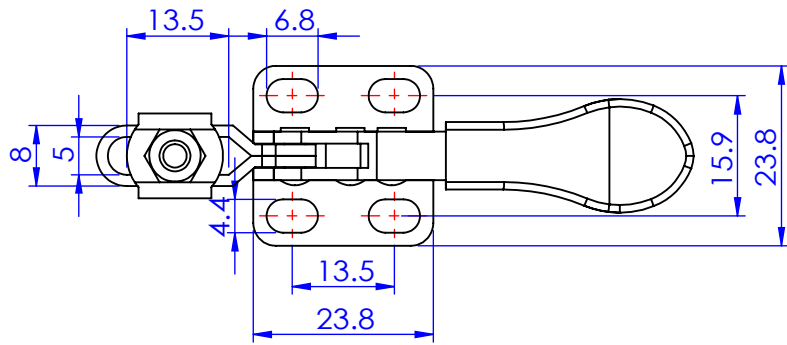

Unit:mm  
Scale: 1:1

 **Good Hand Enterprise Co., Ltd**

TITLE:		
DWG NO.	GH-201-SS	A4