

Part No:	GH-14412
Holding Capacity:	300Kg
Bar Opens:	140°
Handle Opens:	74°
Weight:	1.27Kg
Spindle Supplied:	SA-109015
Flanged Washers:	FW-121

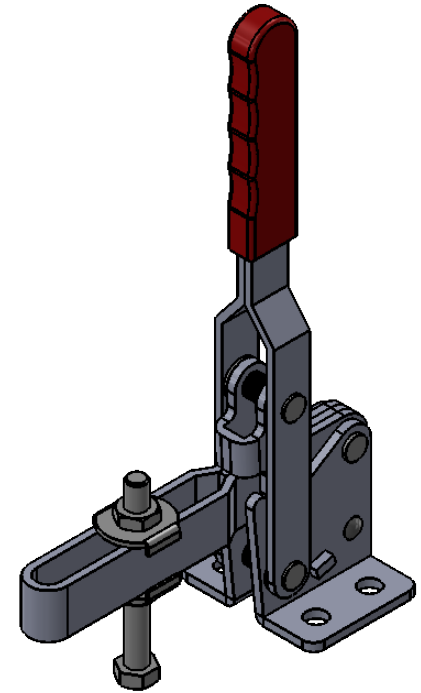
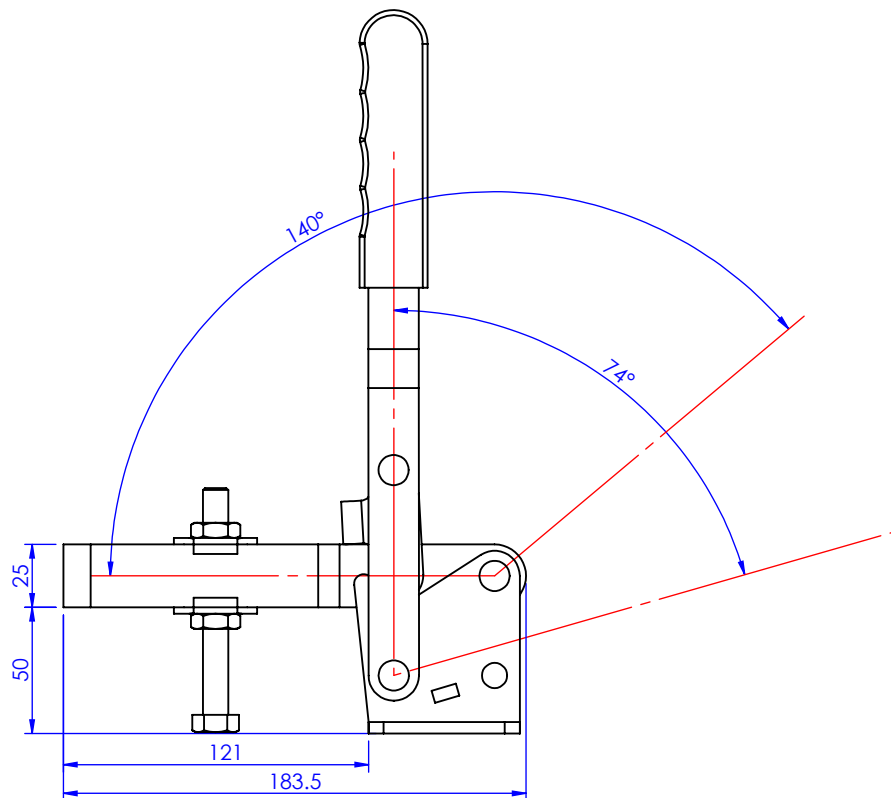
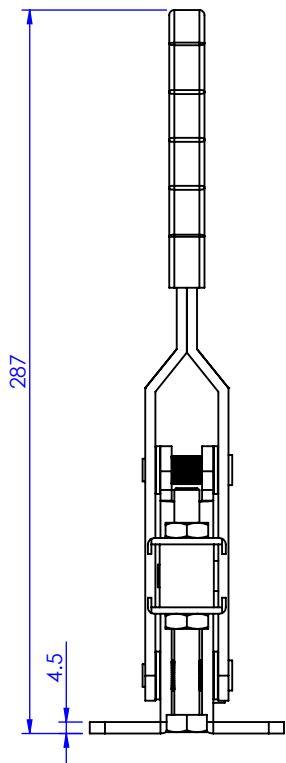
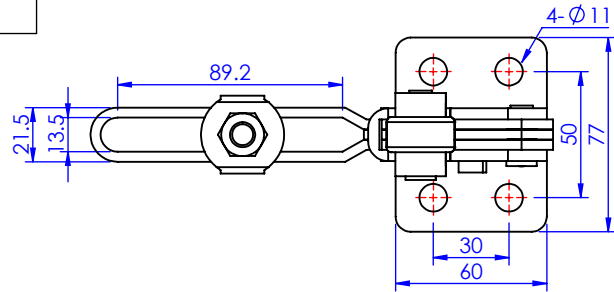

Unit:mm

Scale: 1:3

 **Good Hand Enterprise Co., Ltd**

TITLE:

DWG NO. GH-14412

A4