

Part No:	GH-13009
Holding Capacity:	30Kg
Bar Opens:	80°
Handle Opens:	88°
Weight:	0.05Kg
Spindle Supplied:	FC-044207

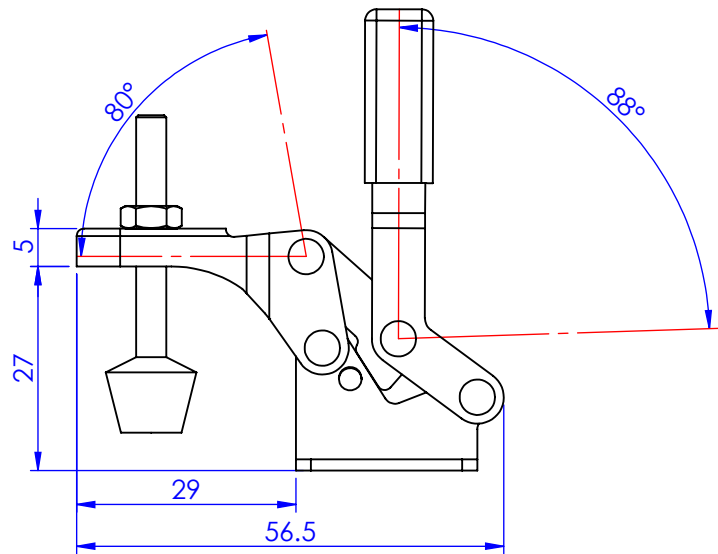
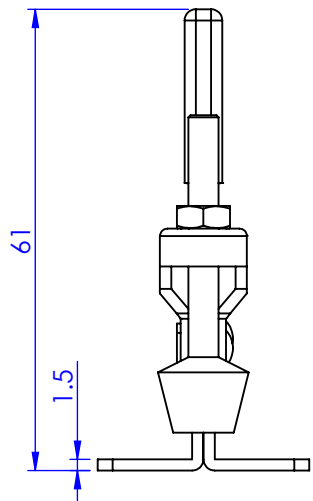
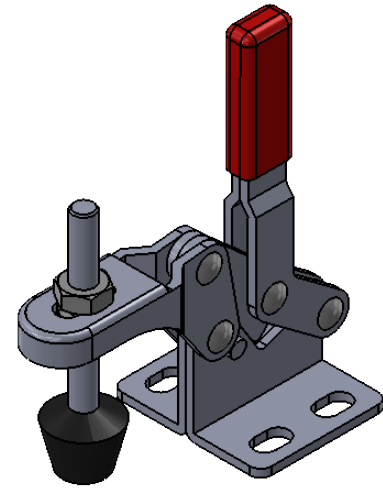
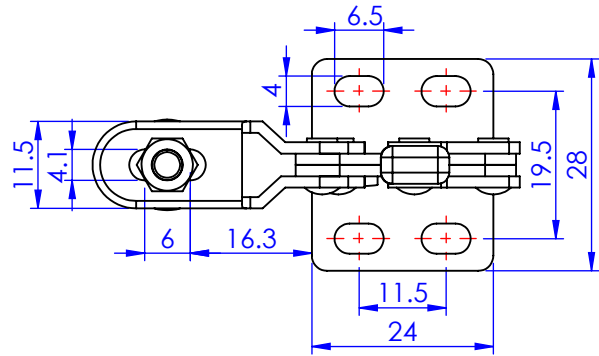

Unit:mm

Scale: 1:1

 **Good Hand Enterprise Co., Ltd**

TITLE:

DWG NO. GH-13009 A4