

Part No:	GH-13008
Holding Capacity:	320Kg
Bar Opens:	90°
Handle Opens:	170°
Weight:	0.59Kg
Spindle Supplied:	FC-108515
Flanged Washers:	FW-380

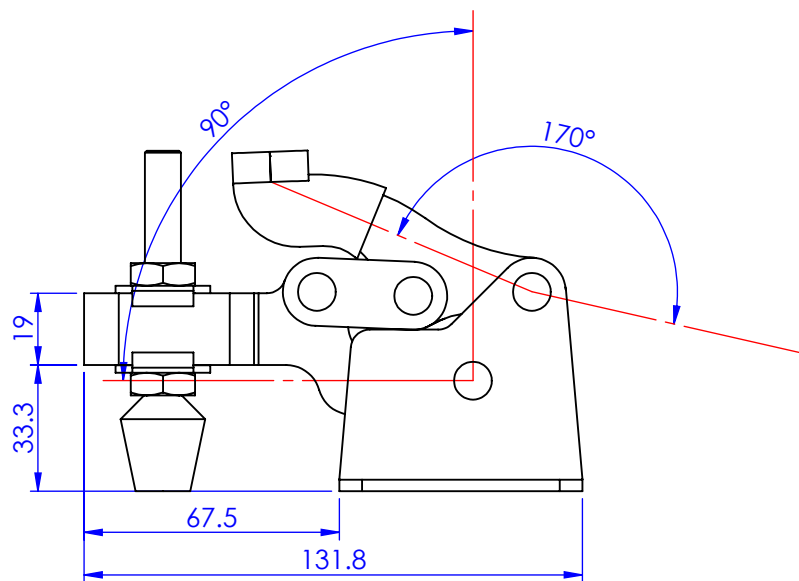
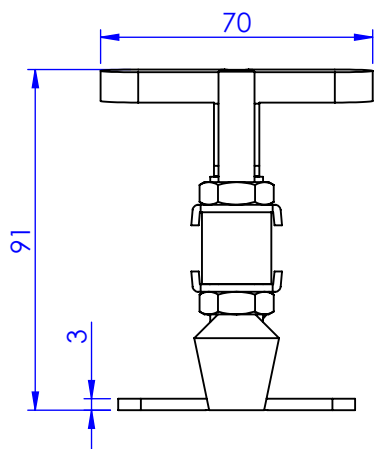
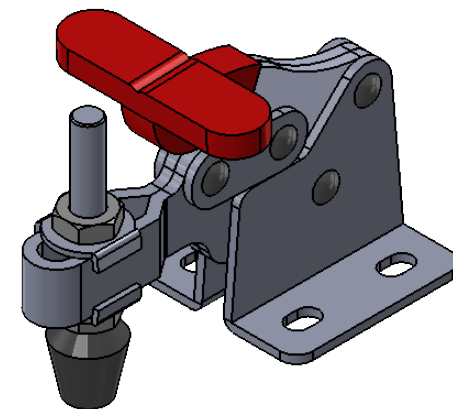
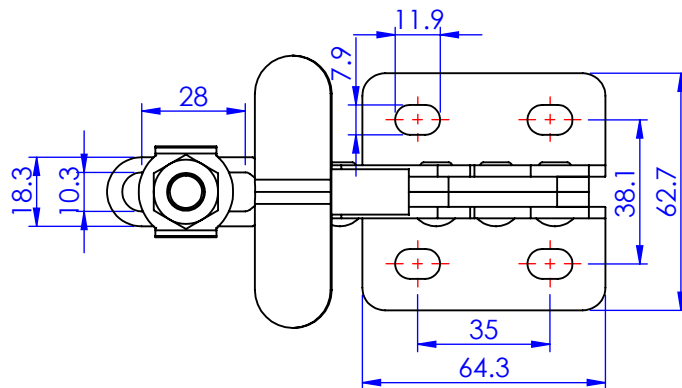

Unit:mm

Scale: 1:2

 **Good Hand Enterprise Co., Ltd**

TITLE:

DWG NO. GH-13008 A4