

Part No:	GH-13007
Holding Capacity:	150Kg
Bar Opens:	90°
Handle Opens:	170°
Weight:	0.26Kg
Spindle Supplied:	FC-086312
Flanged Washers:	FW-516

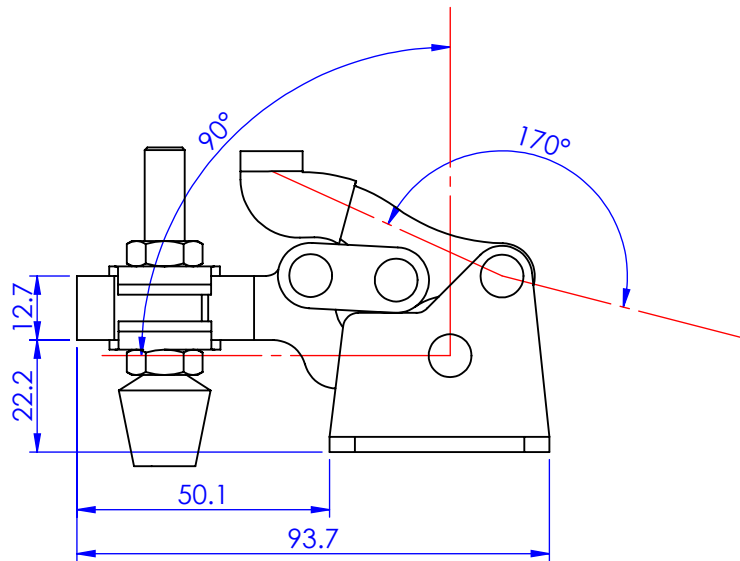

Unit:mm

Scale: 1:1.5

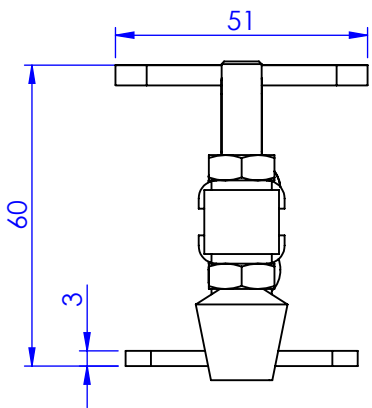
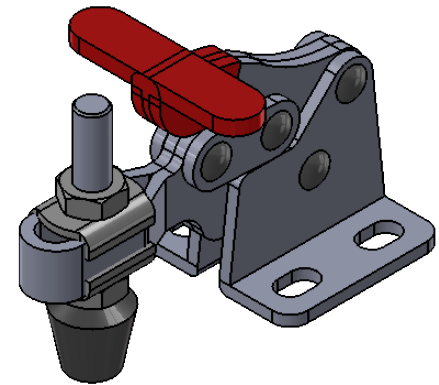
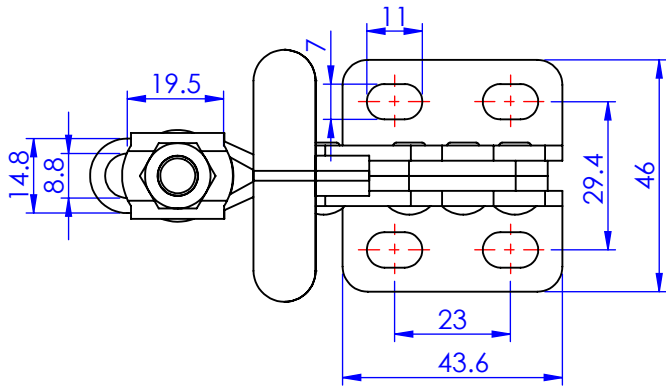

Good Hand Enterprise Co., Ltd

TITLE:

DWG NO.

GH-13007

A4