

Part No:	GH-13003-B
Holding Capacity:	250Kg
Bar Opens:	106°
Handle Opens:	67°
Weight:	0.6Kg
Spindle Supplied:	SA-086512
Flanged Washers:	FW-516

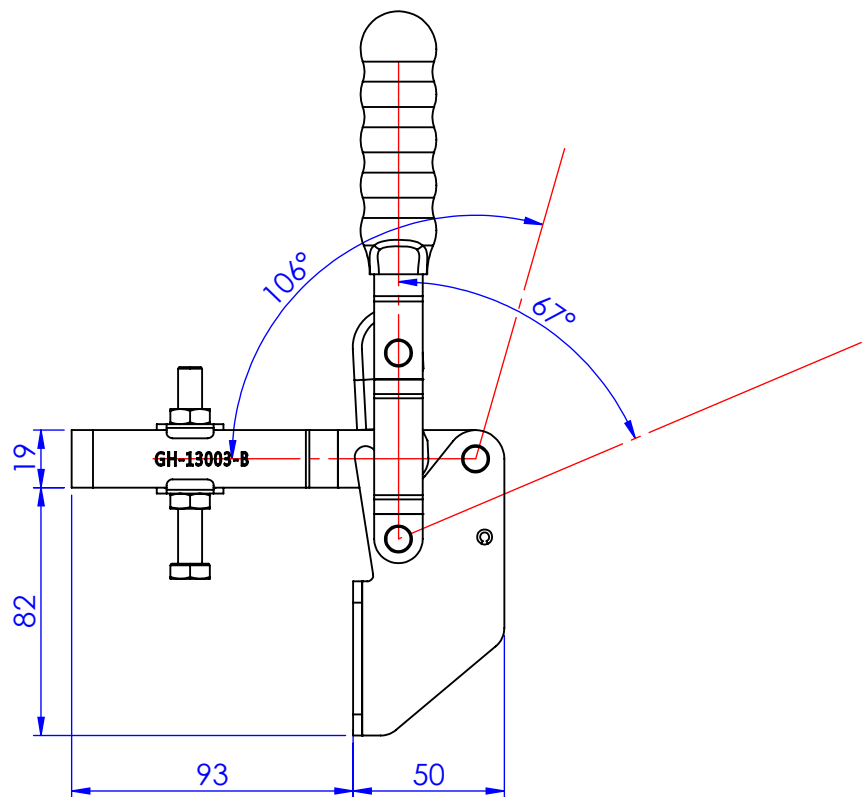
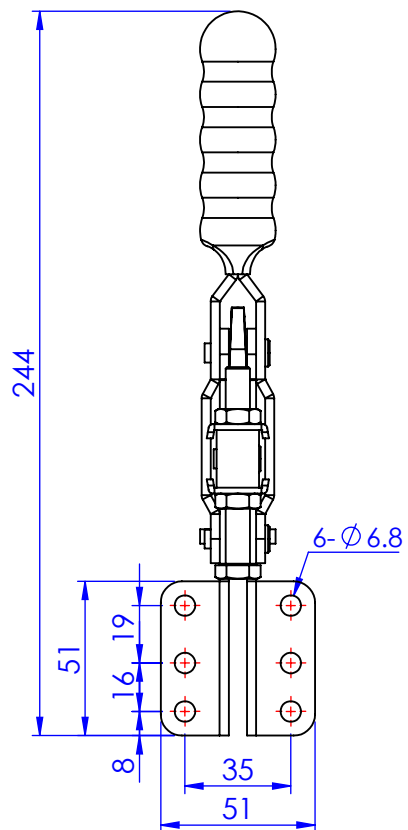
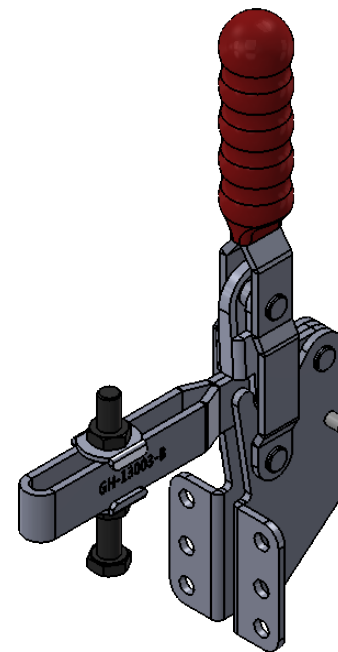
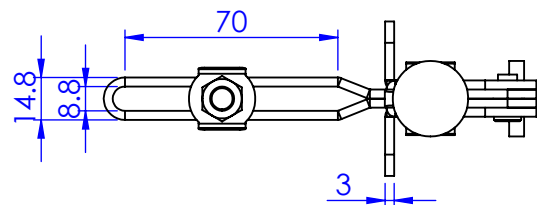

Unit:mm

Scale: 1:2.5

 **Good Hand Enterprise Co., Ltd**

TITLE:

DWG NO. GH-13003-B A4