

Part No:	GH-12502-B
Holding Capacity:	250Kg
Bar Opens:	90° / 150°
Handle Opens:	70° / 100°
Weight:	0.435Kg
Spindle Supplied:	SA-086512
Flanged Washers:	FW-516

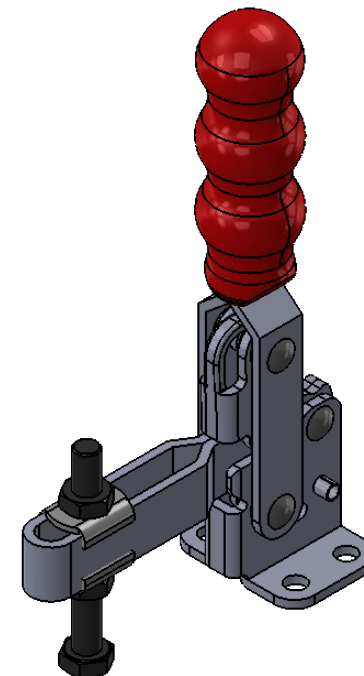
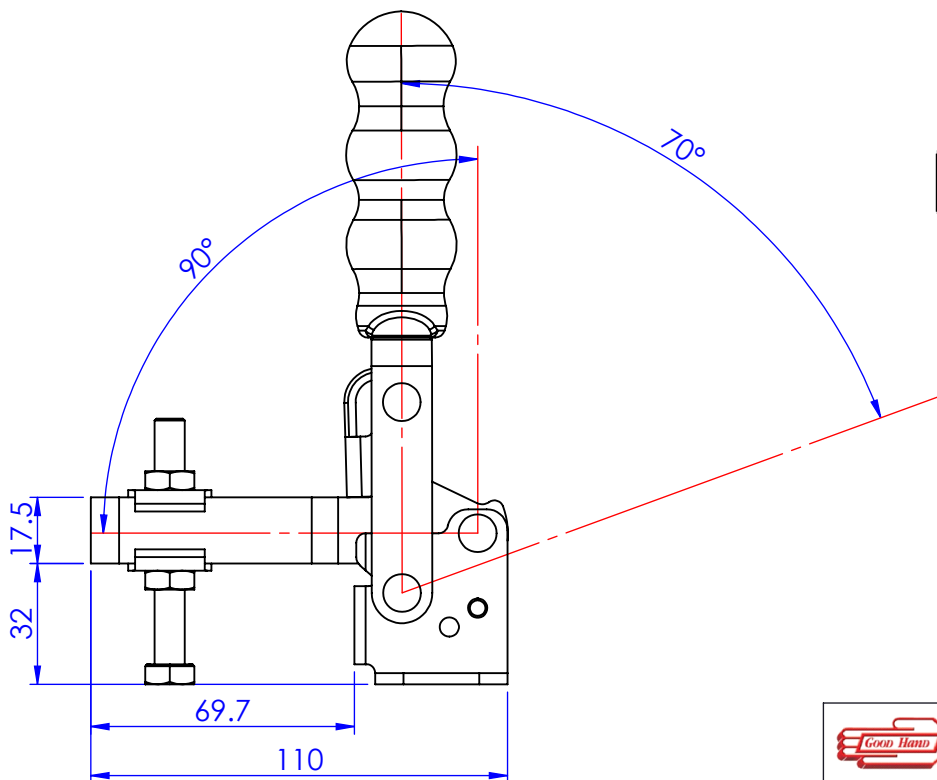
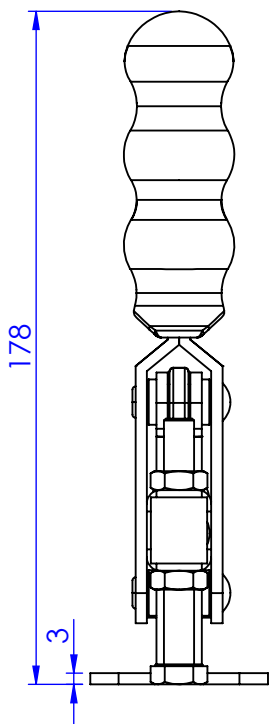
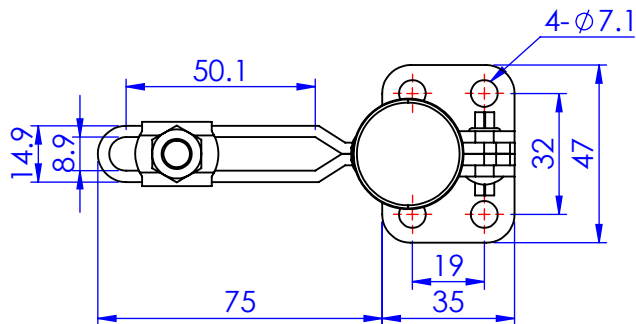

Unit:mm

Scale: 1:2

 **Good Hand Enterprise Co., Ltd**

TITLE:

DWG NO. GH-12502-B A4