

Part No:	GH-12305
Holding Capacity:	364Kg
Bar Opens:	100°
Handle Opens:	65°
Weight:	1.09Kg
Spindle Supplied:	FC-108515
Flanged Washers:	FW-380

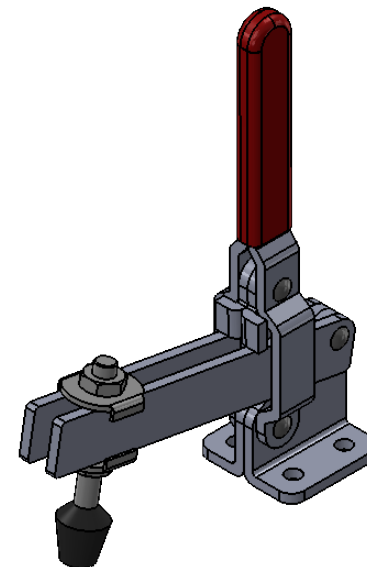
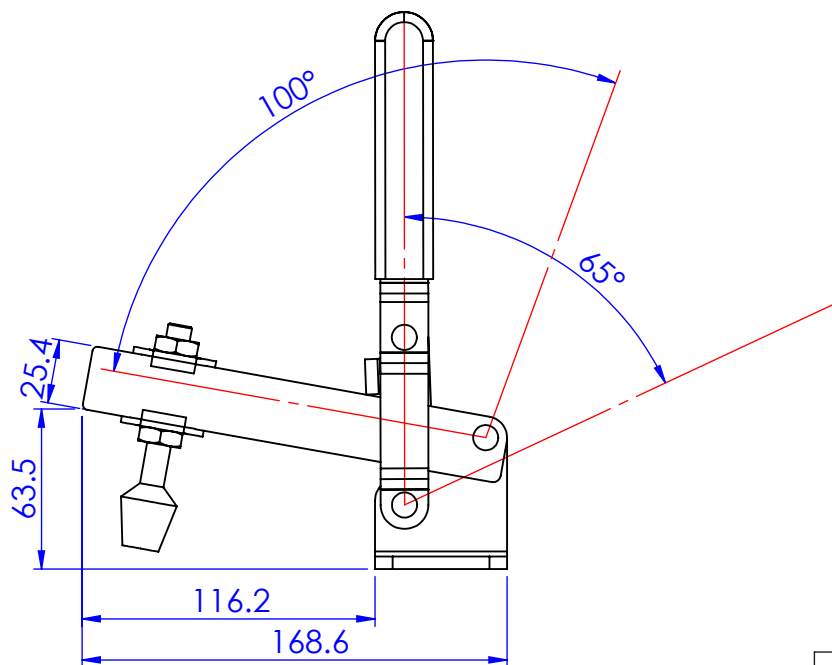
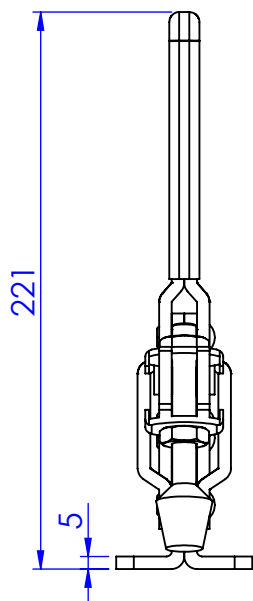
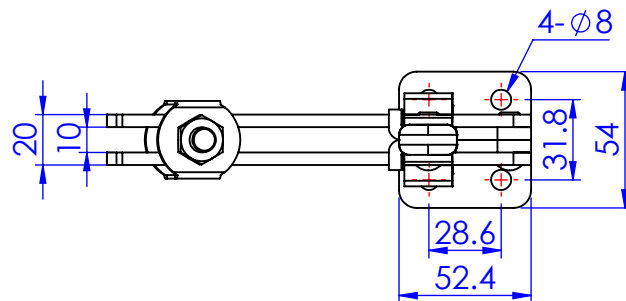

Unit:mm

Scale: 1:3

 **Good Hand Enterprise Co., Ltd**

TITLE:

DWG NO. GH-12305 A4