

Part No:	GH-12265
Holding Capacity:	340Kg
Bar Opens:	112°
Handle Opens:	61°
Weight:	0.65Kg
Spindle Supplied:	FC-108515
Flanged Washers:	FW-380

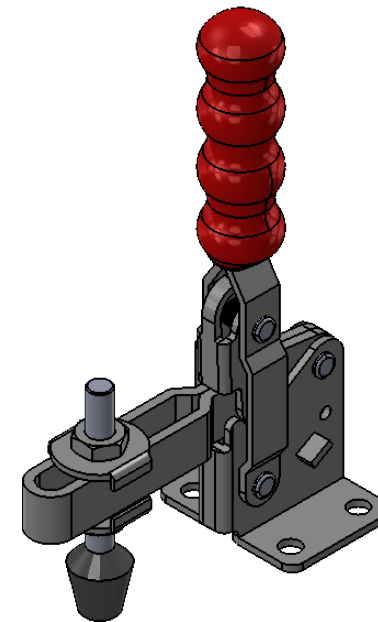
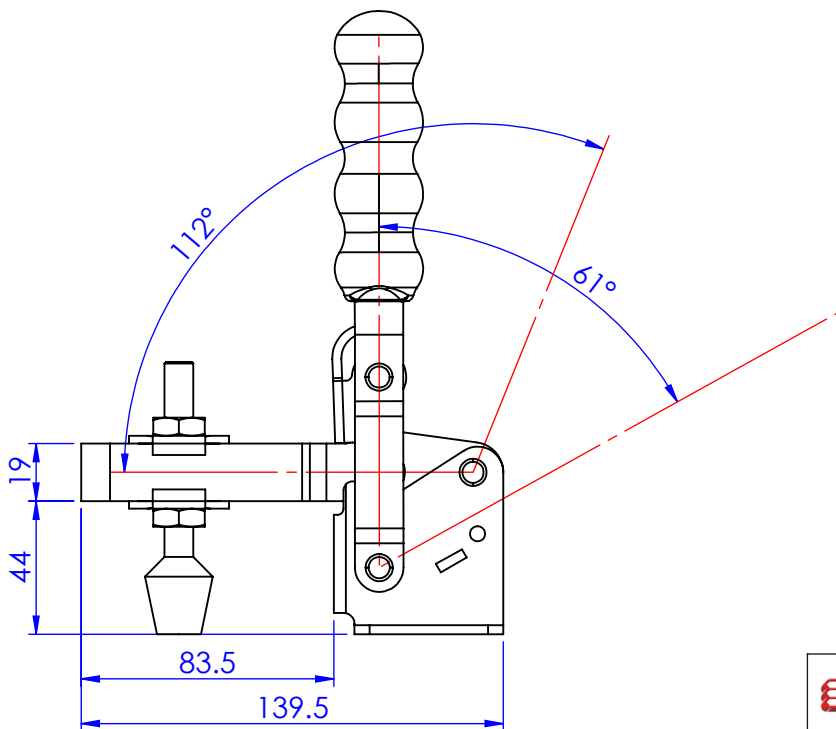
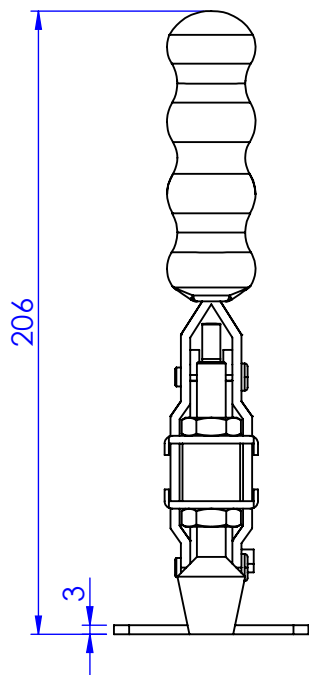
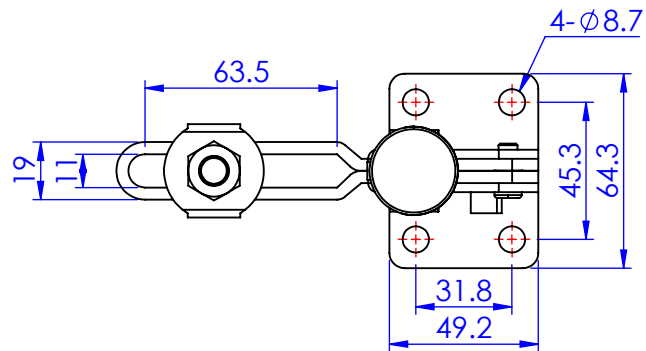

Unit:mm
Scale: 1:2.5

 **Good Hand Enterprise Co., Ltd**

TITLE:		
DWG NO.	GH-12265	A4