

Part No:	GH-12131
Holding Capacity:	227Kg
Bar Opens:	100°
Handle Opens:	56°
Weight:	0.38Kg
Spindle Supplied:	FC-086312
Flanged Washers:	FW-516

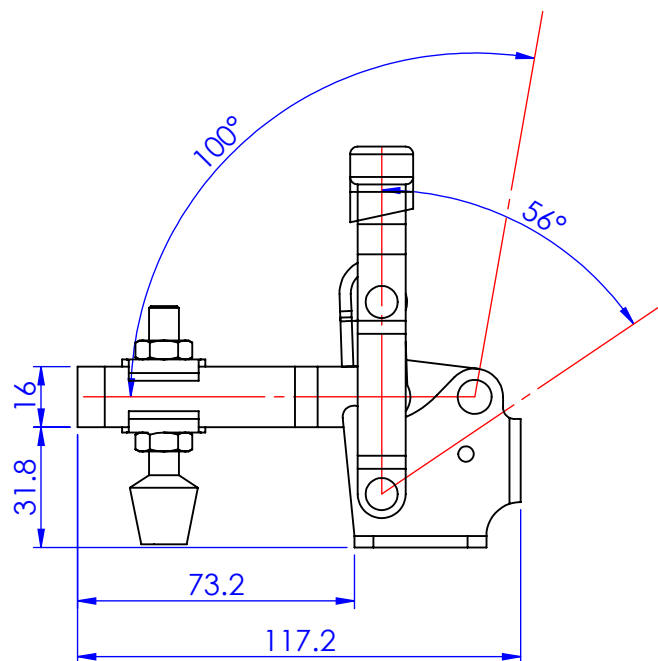
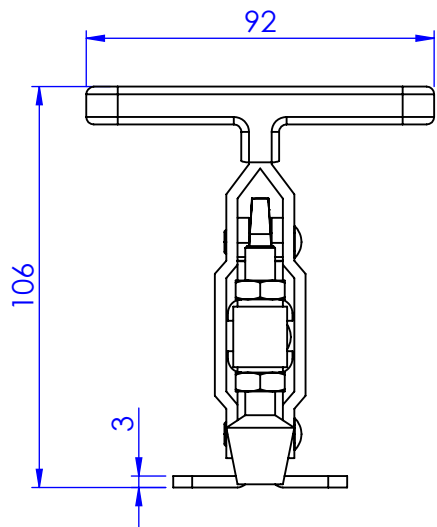
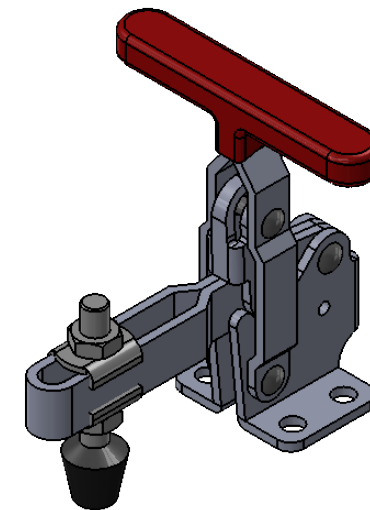
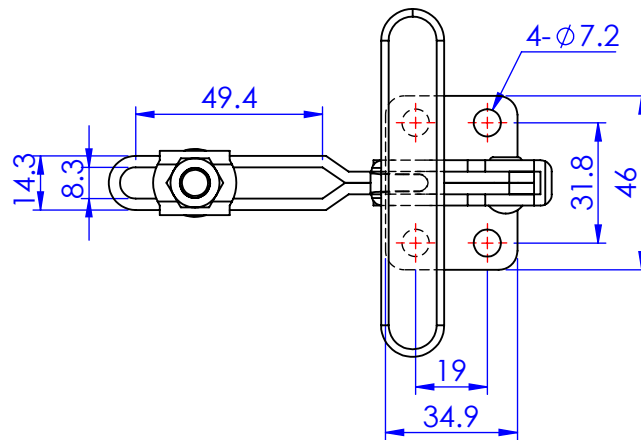

Unit:mm

Scale: 1:2

 **Good Hand Enterprise Co., Ltd**

TITLE:

DWG NO. GH-12131 A4