

Part No:	GH-12130-SS
Holding Capacity:	227Kg
Bar Opens:	100°
Handle Opens:	56°
Weight:	0.35Kg
Spindle Supplied:	SA-085012-SS
Flanged Washers:	FW-516-SS

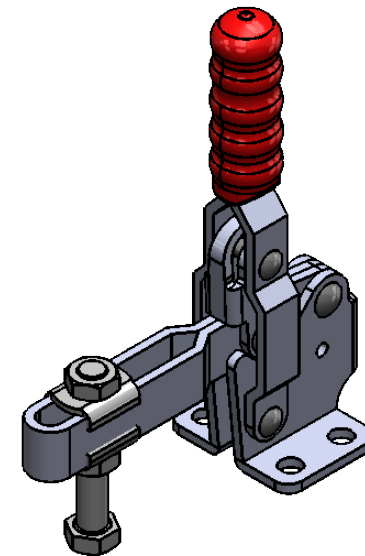
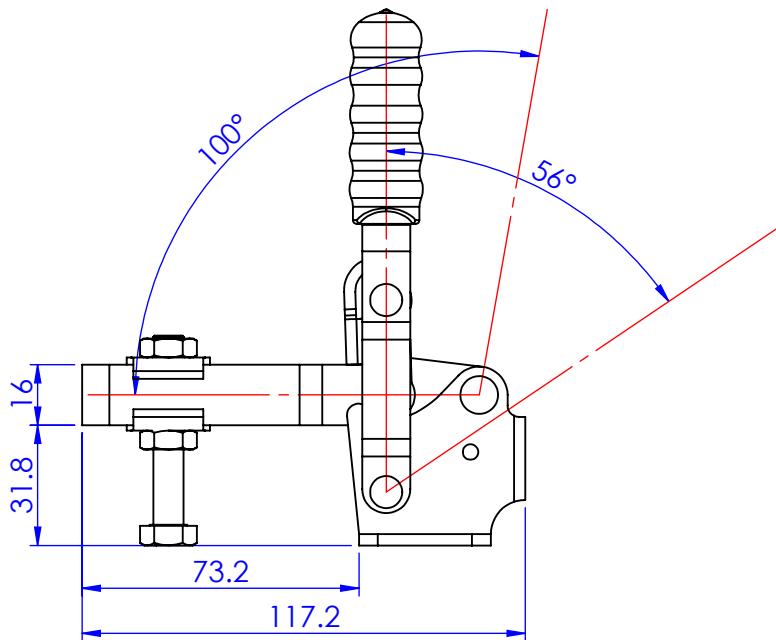
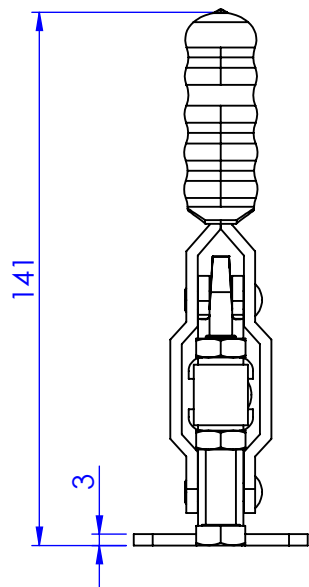
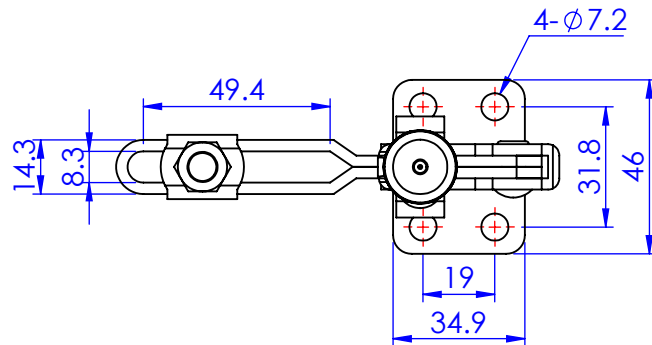

Unit:mm

Scale: 1:2

 **Good Hand Enterprise Co., Ltd**

TITLE:		
DWG NO.	GH-12130-SS	A4