

Part No:	GH-12085
Holding Capacity:	91Kg
Bar Opens:	95°
Handle Opens:	60°
Weight:	0.174Kg
Spindle Supplied:	FC-064410
Bolt Retainer:	BR-140

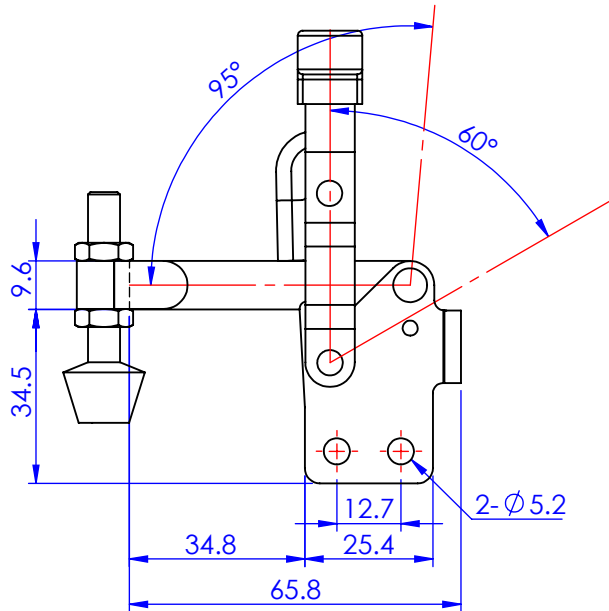

Unit:mm

Scale: 1:1.5

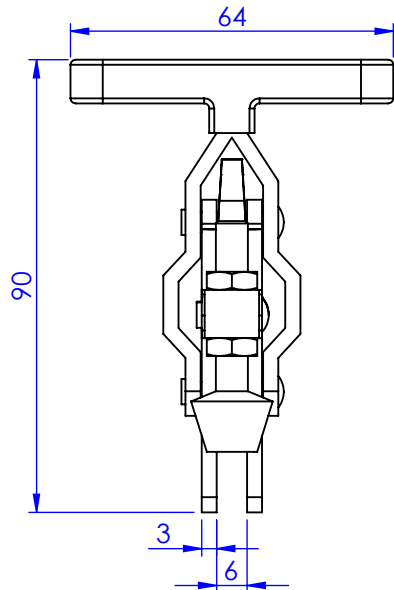
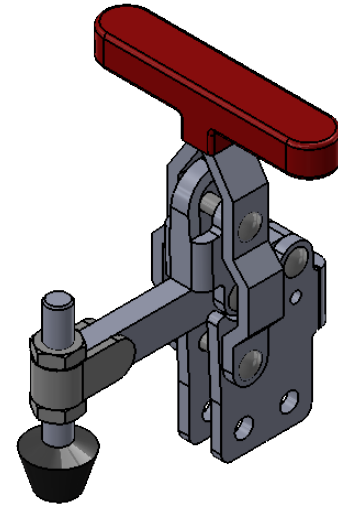
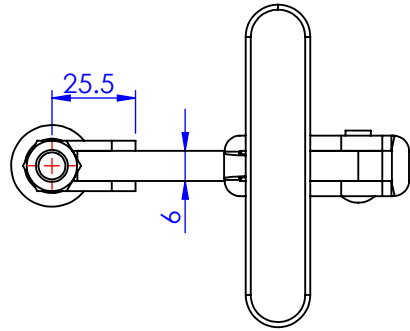

Good Hand Enterprise Co., Ltd

TITLE:	
DWG NO.	GH-12085
	A4