

Part No:	GH-12003-B
Holding Capacity:	150Kg
Bar Opens:	108°
Handle Opens:	70°
Weight:	0.28Kg
Spindle Supplied:	SA-065010+NC-06
Flanged Washers:	FW-140

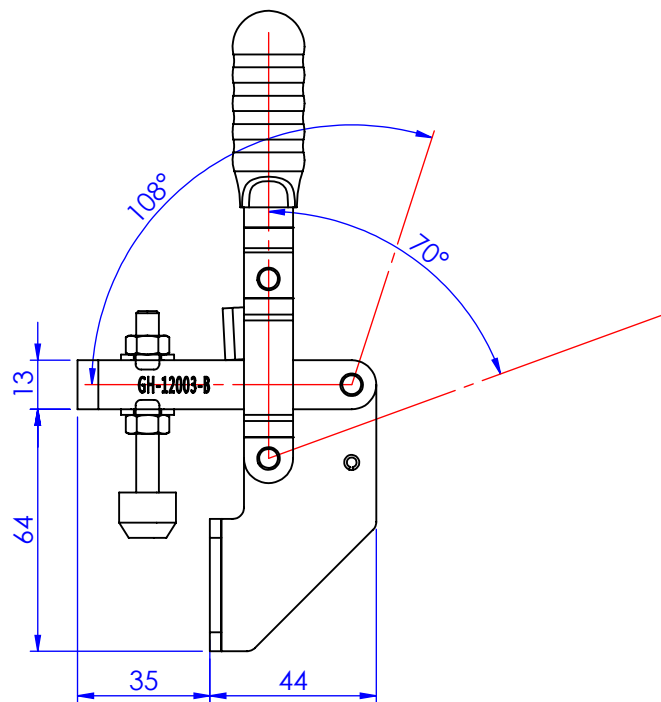
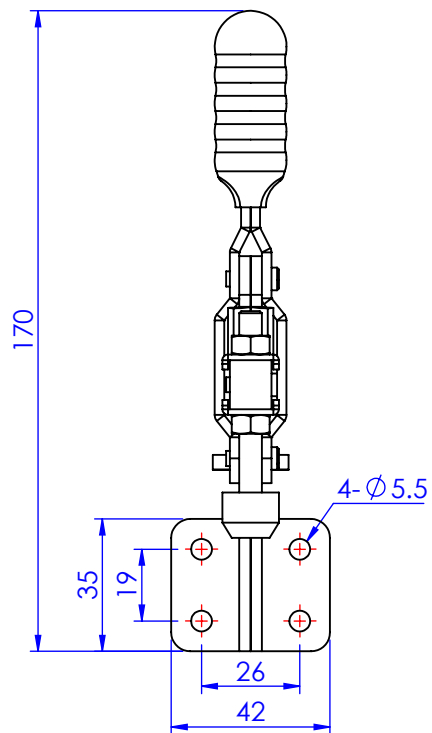
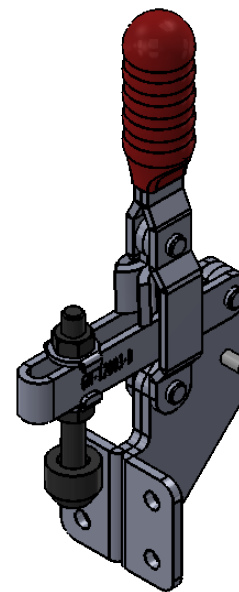
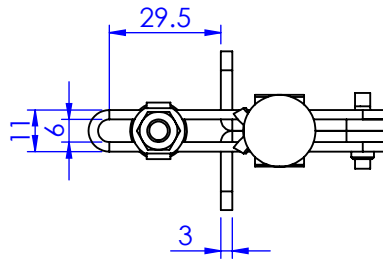

Unit:mm

Scale: 1:2

 **Good Hand Enterprise Co., Ltd**

TITLE:		
DWG NO.	GH-12003-B	A4