

Part No:	GH-12002-B
Holding Capacity:	150Kg
Bar Opens:	108°
Handle Opens:	70°
Weight:	0.244Kg
Spindle Supplied:	SA-065010+NC-06
Flanged Washers:	FW-140

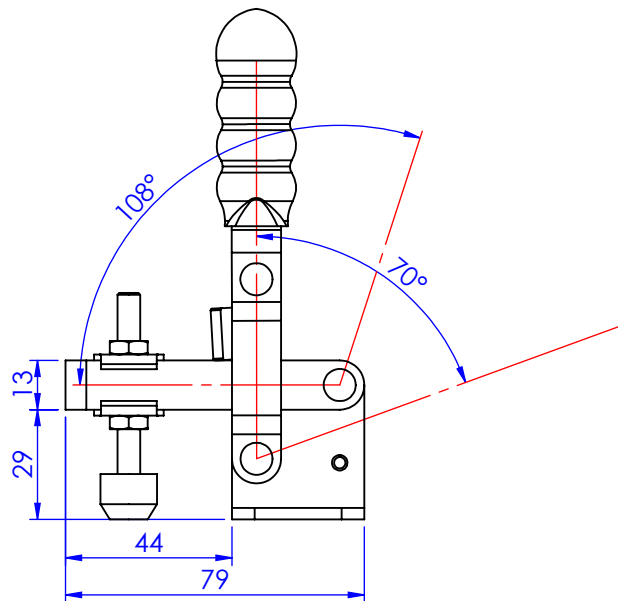
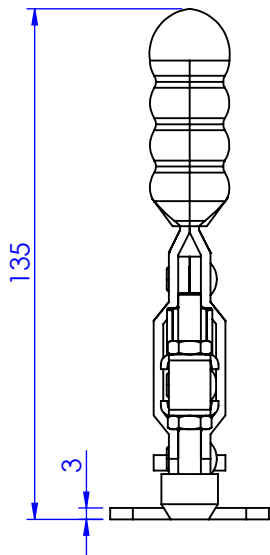
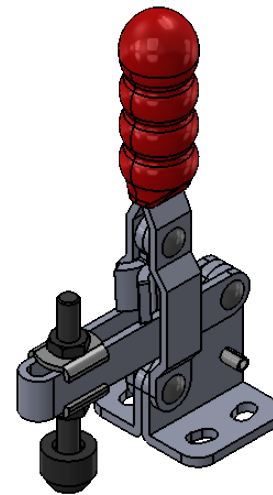
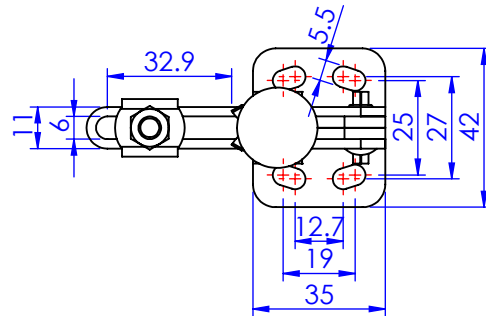

Unit:mm

Scale: 1:2

 **Good Hand Enterprise Co., Ltd**

TITLE:

DWG NO. GH-12002-B A4