

Part No:	GH-11421-SS
Holding Capacity:	200Kg
Bar Opens:	94°
Handle Opens:	54°
Weight:	0.366Kg
Spindle Supplied:	SA-085012-SS
Flanged Washers:	FW-380-SS

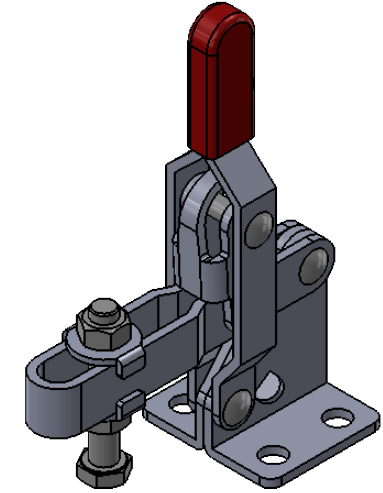
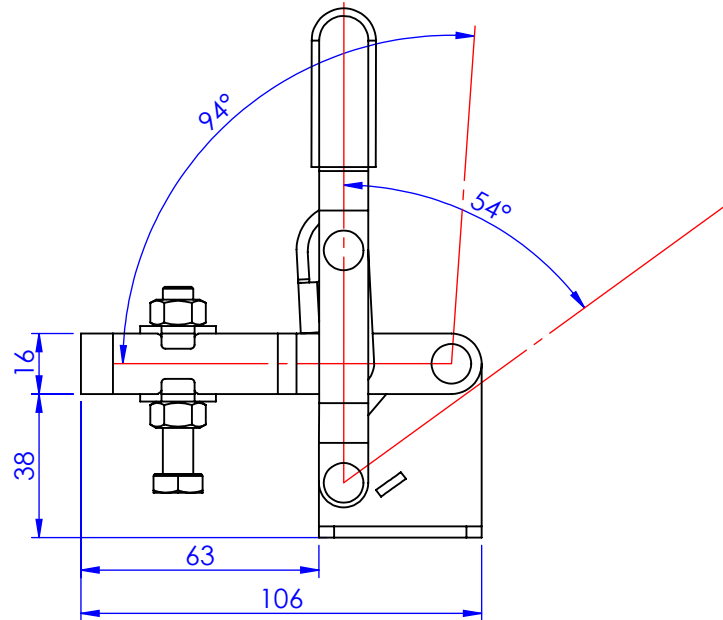
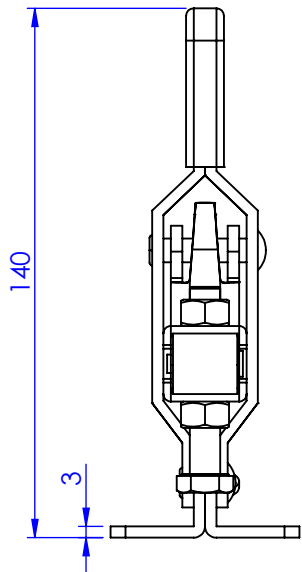
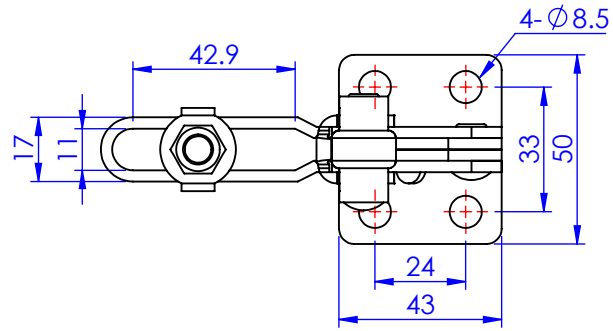

Unit:mm

Scale: 1:2

 **Good Hand Enterprise Co., Ltd**

TITLE:

DWG NO. GH-11421-SS A4