

Part No:	GH-102-B
Holding Capacity:	100Kg
Bar Opens:	90°
Handle Opens:	65°
Weight:	0.11Kg
Spindle Supplied:	FC-064410
Flanged Washers:	FW-142

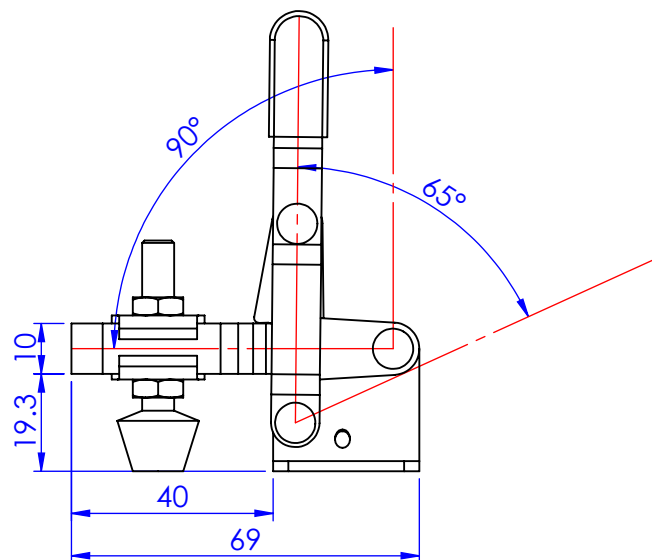
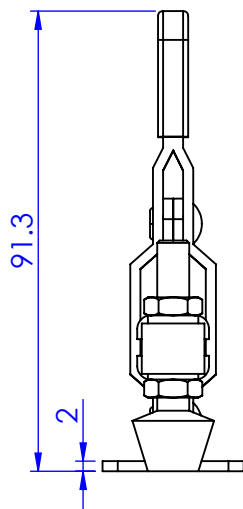
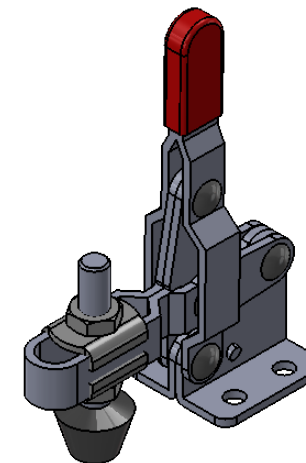
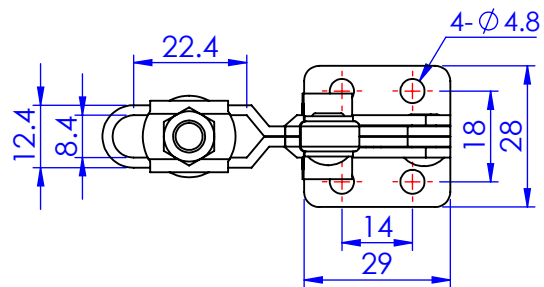

Unit:mm
Scale: 1:1.5

 **Good Hand Enterprise Co., Ltd**

TITLE:

DWG NO. GH-102-B A4