

Part No:	GH-36010M
Holding Capacity:	364Kg
Plunger Stroke:	41.3 mm
Handle Opens:	180°
Weight:	0.8Kg
Spindle Supplied:	SA-105015

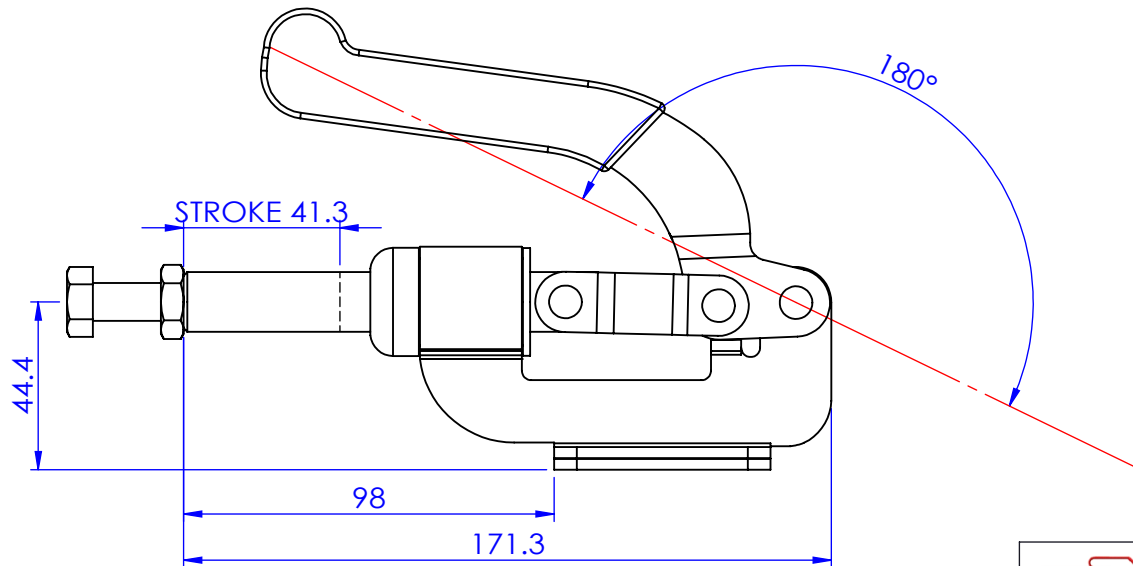
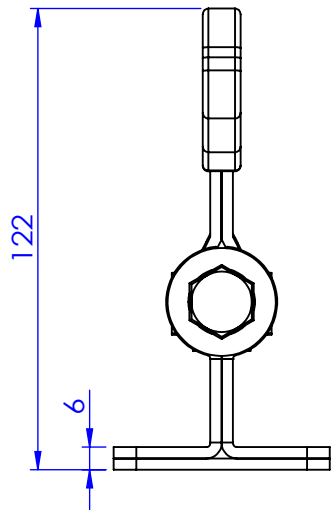
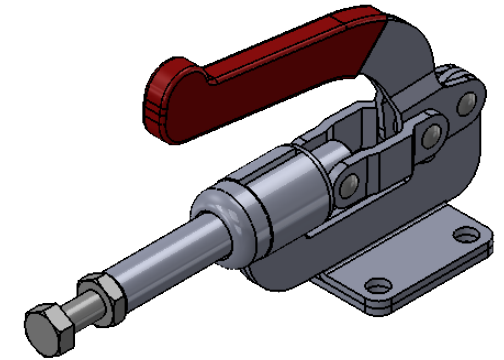
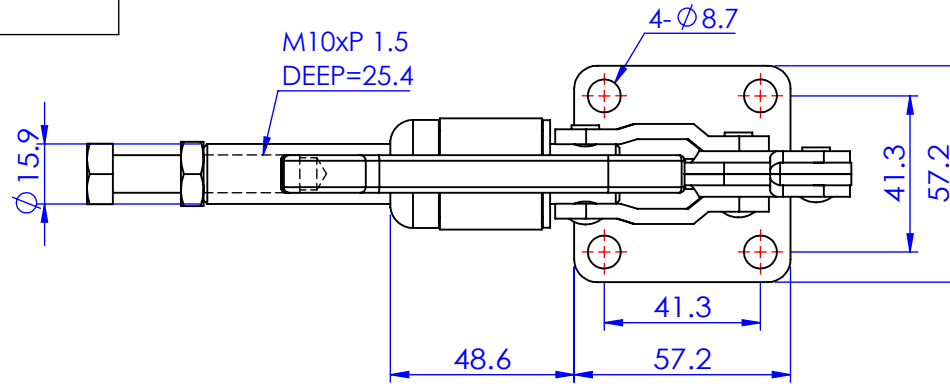

Unit:mm
Scale: 1:2

 **Good Hand Enterprise Co., Ltd**

TITLE:

DWG NO. GH-36010M A4