

Part No:	GH-220-WH
Holding Capacity:	400Kg
Bar Opens:	84°
Handle Opens:	90°
Weight:	0.74Kg
Spindle Supplied:	FC-108515
Flanged Washers:	FW-380

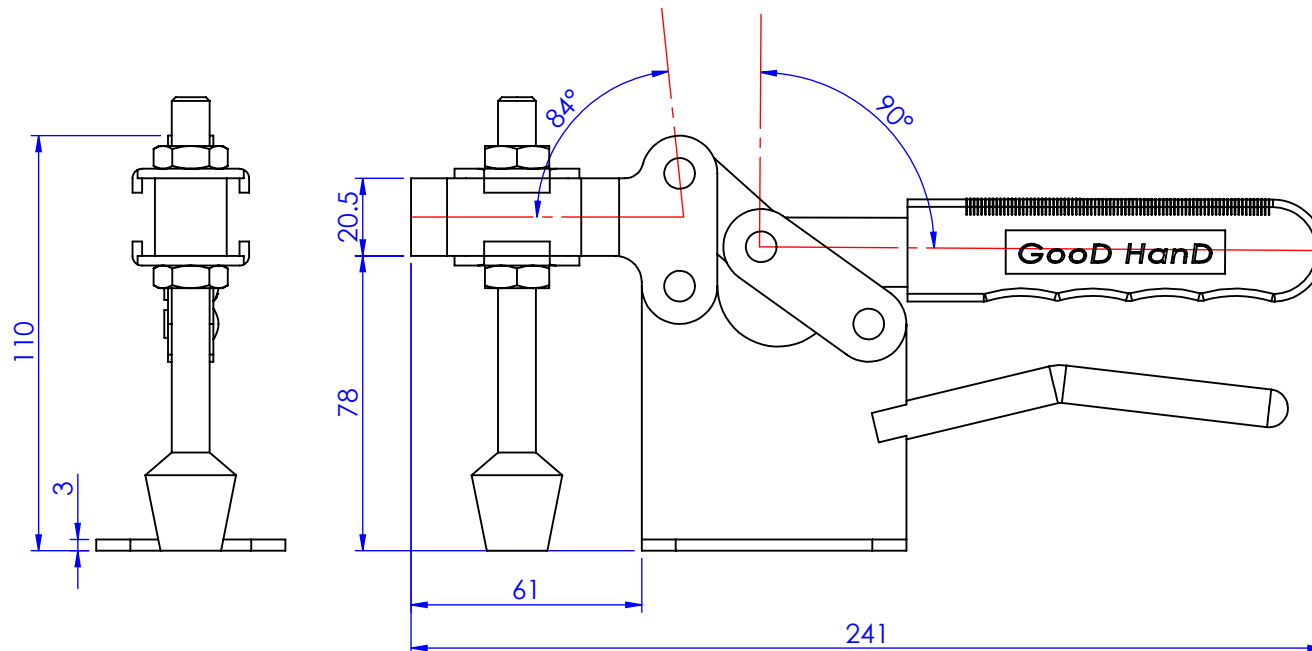
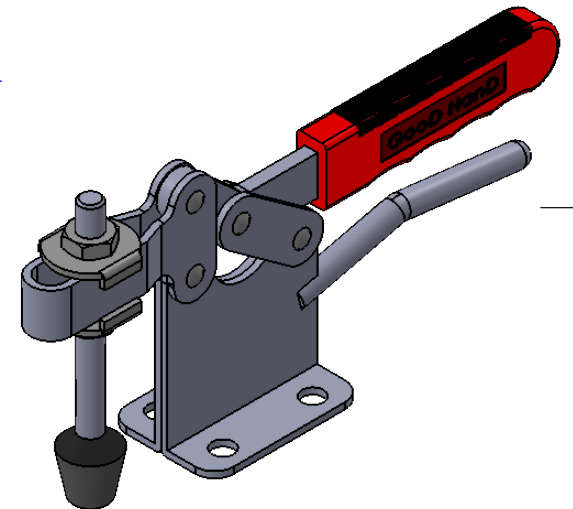
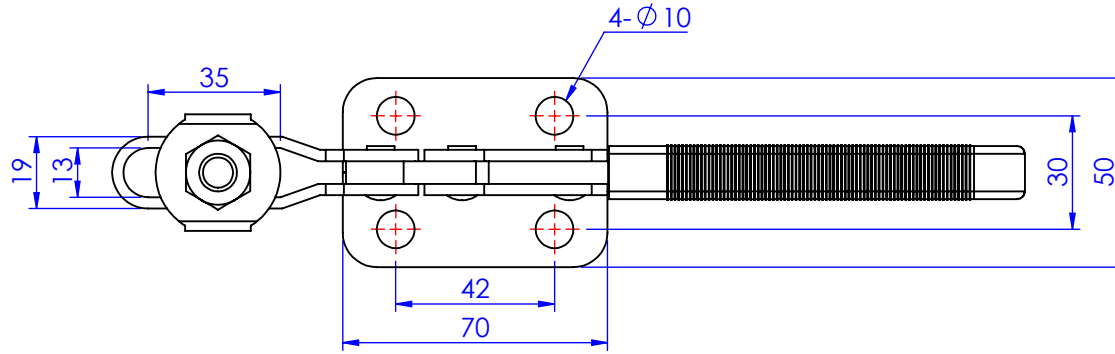

Unit:mm
Scale : 1:2

 **Good Hand Enterprise Co., Ltd**

TITLE:		
DWG NO.	GH-220-WH	A4