

Part No:	GH-12132-A
Holding Capacity:	227Kgf
Bar Opens:	55°
Weight:	0.88Kg
Spindle Supplied:	FC-086312
Flanged Washers:	FW-516
Air Connection Size:	1/8PT
Cylinder Bore:	30mm
Max Cylinder Air Pressure:	10Kgf/cm ²
Optional Magnetic Sensors:	MT-22

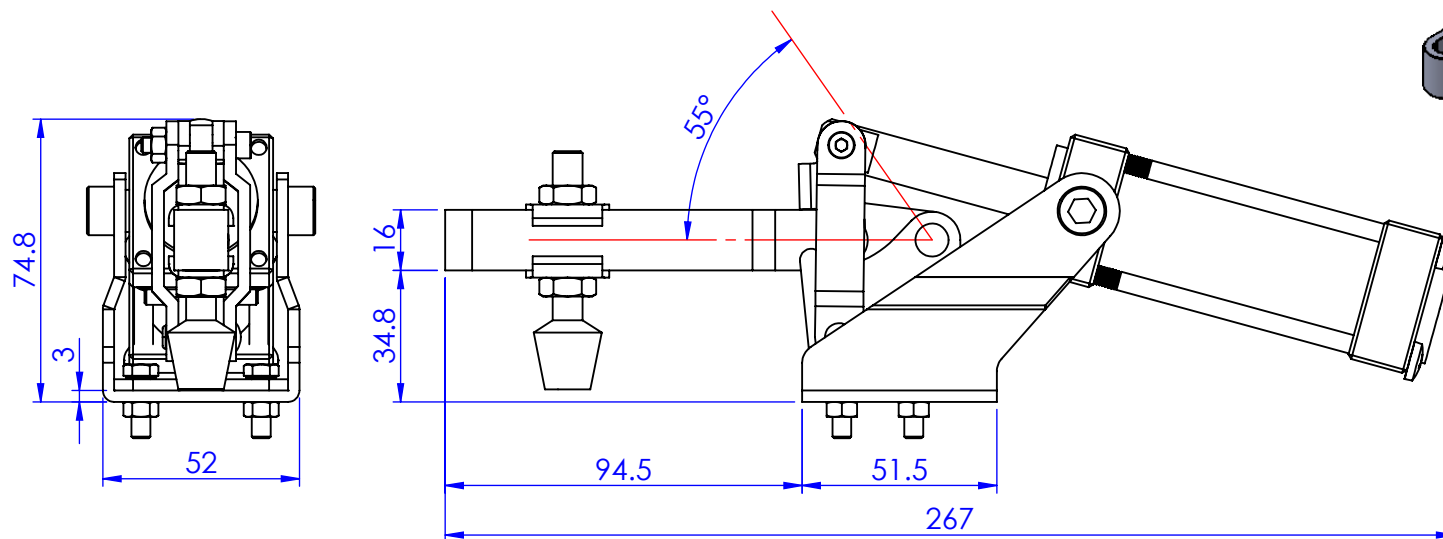
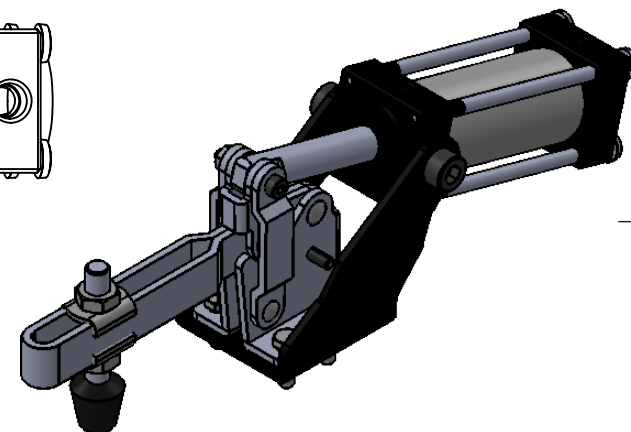
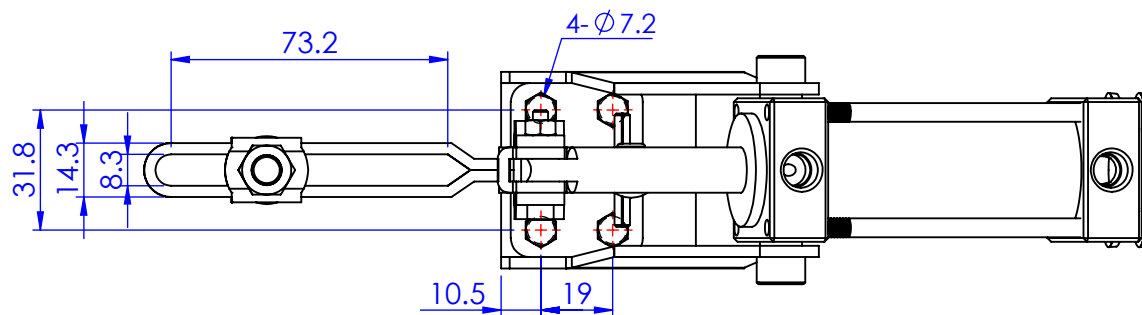

Unit:mm

Scale: 1:2

 **Good Hand Enterprise Co., Ltd**

TITLE:		
DWG NO.	GH-12132-A	A4